

MARVIK 2 - MV-30013

THAILAND
 LIGMAN Lighting Co.,Ltd.
 17/2 Moo 4, Monthong,
 Bang Nam Prio,ao,
 24150 Chachoengsao
 Thailand
 info@ligman.com

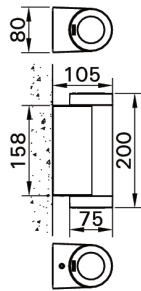

Product drawing (dimensions)



MV-30031 Weight : 1.7 kg

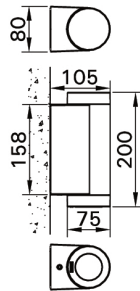

MV-30001-02 Weight : 1.6 kg

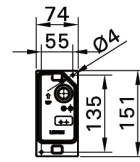

MARVIK 1,4
MOUNTING DETAIL

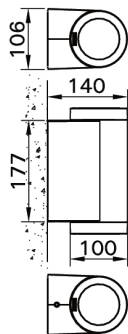
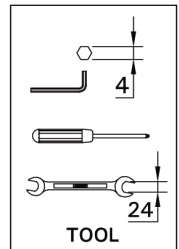

MV-30041 Weight : 2.7 kg
 MV-30042 Weight : 2.8 kg

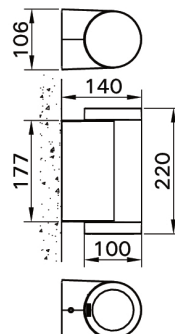

MV-30011-12-13 Weight : 2.6 kg

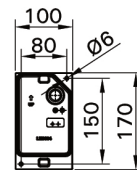

MARVIK 2,5
MOUNTING DETAIL

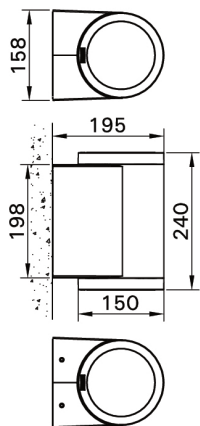

MV-30051 Weight : 4.6 kg
 MV-30052 Weight : 5.3 kg

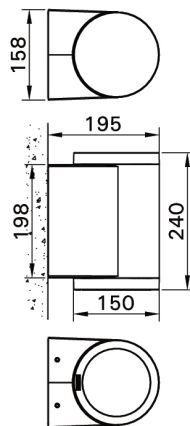

MV-30021-22 Weight : 4.5 kg
 MV-30023 Weight : 4.8 kg

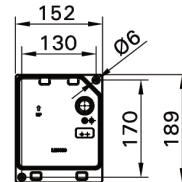

MARVIK 3,6
MOUNTING DETAIL

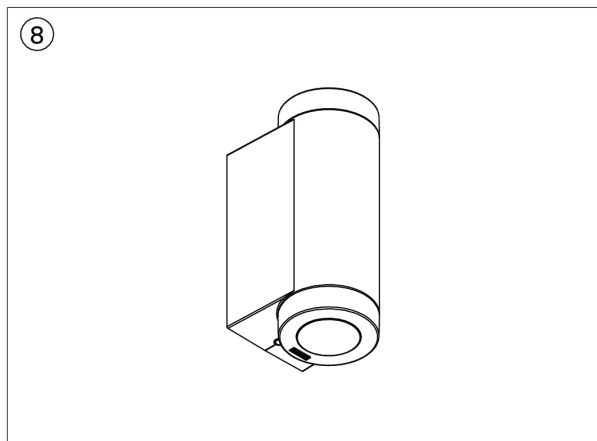
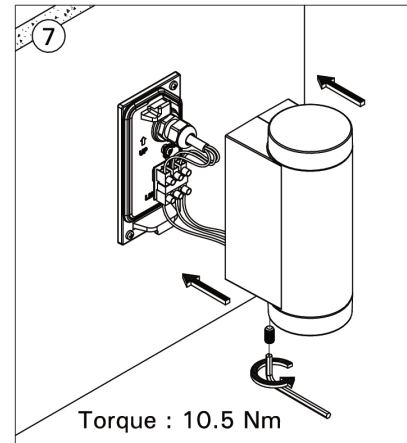
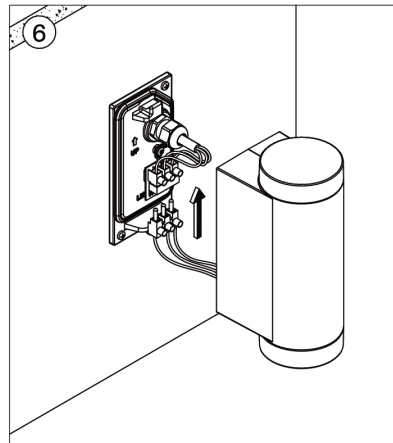
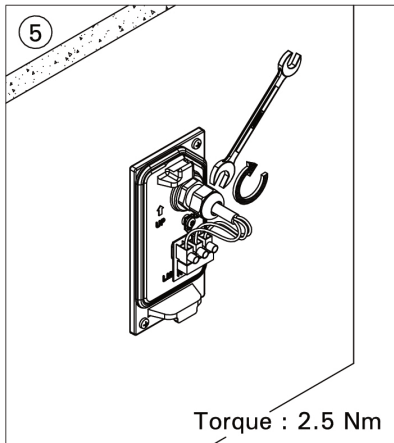
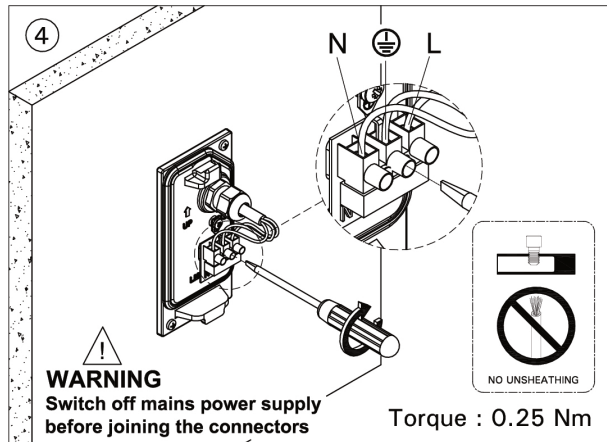
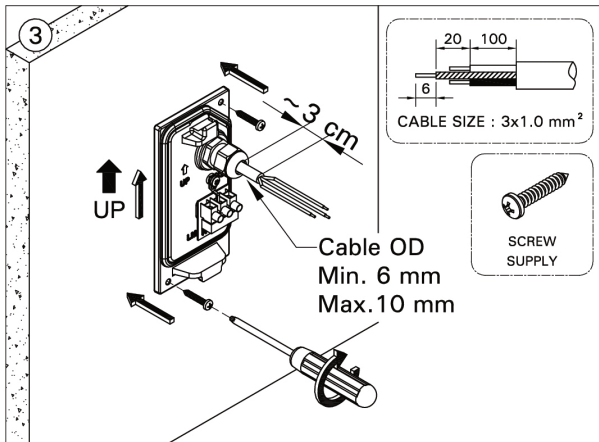
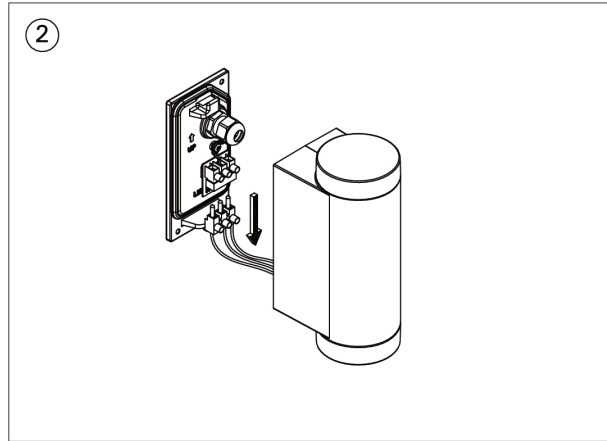
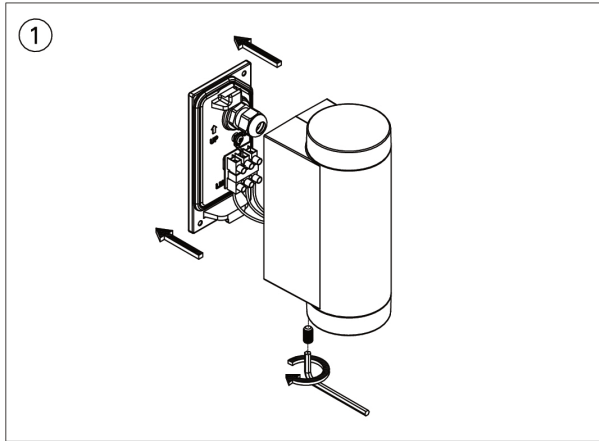

Procedure for removing / replacing the light source (LS) / the control gear (CG)

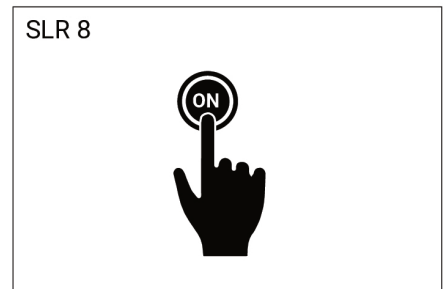
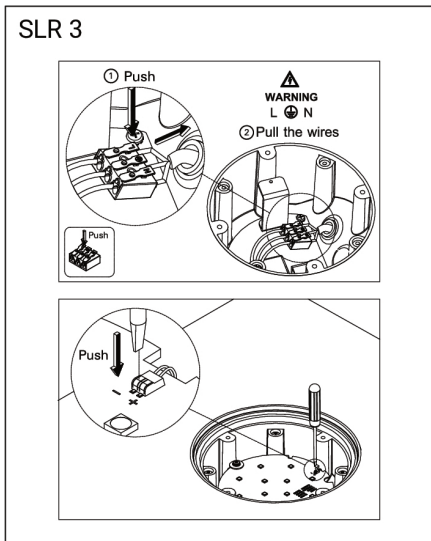
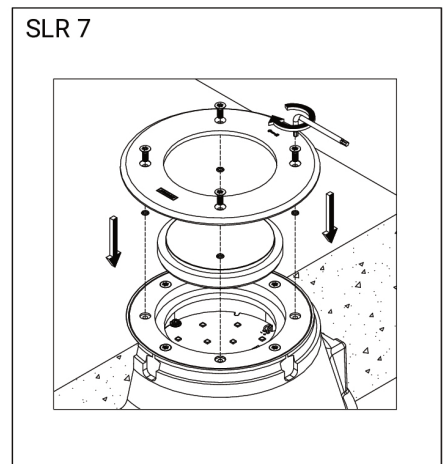
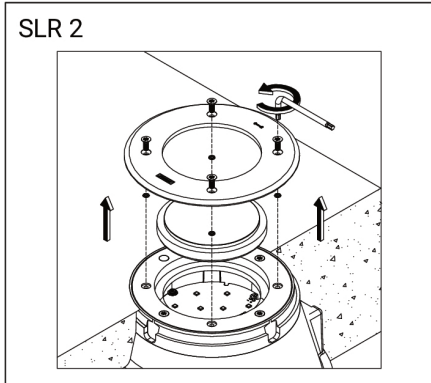
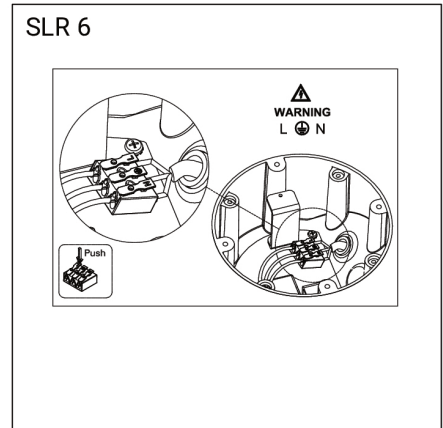

CATATAN

- Agar tidak merusak lumener selama pemasangan, harap periksa nilai torsi untuk diterapkan pada setiap langkah.

SINGLE LIGHTING REGULATION (SLR)

- Prosedur melepas / mengganti sumber cahaya (LS) / Control Gear (CG)

- SLR 1: Matikan daya

- SLR 2: Buka penutupnya

- SLR 3: Lepaskan kabel

- SLR 4: Longgarkan sekrup pengencang dan ganti sumber cahaya (LS) jika perlu

-- PERINGATAN! Periksa apakah polaritas +/- sudah benar sesuai dengan simbol / warna kabel

-- Pasang di posisi semula dan pasang kembali sekrupnya

- SLR 5: Longgarkan sekrup pengencang dan ganti control gear (CG) jika perlu

-- Pasang di posisi semula dan pasang kembali sekrupnya

- SLR 6: Sambungkan kembali kabel

- SLR 7: Tutup penutupnya

-- PERINGATAN! Hati-hati jangan sampai merusak kabel saat menutup penutup

- SLR 8: Nyalakan daya