

# ABERDEEN



Sophisticated, yet robust, public realm area-lighting post top. High IP and IK resistance with elegant lines and commanding technical optical performance choices to meet any lighting brief.



**LIGHT CONNECT™**



## Luminaire Structure

- Die-cast aluminium housing

- Pre-treated before powder coating ensuring high corrosion resistance  
 - Stainless steel fasteners in grade 304 with zinc flake coating (ZFC)

- Durable silicone rubber gasket  
 - High-efficiency PMMA lens  
 - Clear acrylic PMMA diffuser

## Feature



## Optic

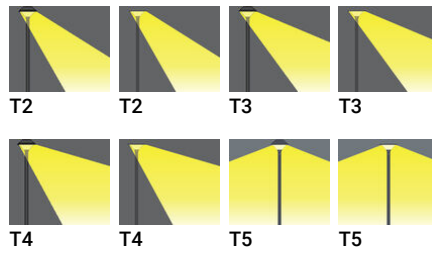

## Product colour

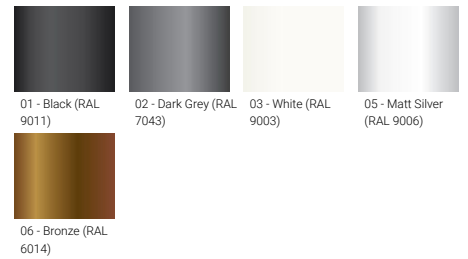

## Special finishes upon request

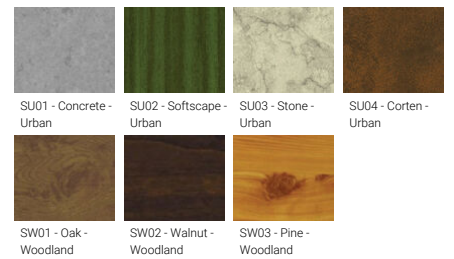





# ABERDEEN

## Technical information

	Model number	Light source	Power	Lumen	Optic	CCT / CRI	Dimming type	Weight	
<b>Top Ø700</b>									
ABERDEEN 1	<b>ABA-20001</b>	24 LED	45 W	5627 - 6228 lm	T2 [142°x59°], T3 [142°x72°], T4 [102°x63°], T5 [119°x147°]	3000K CRI80, 4000K CRI80	On/Off, 1-10V, DALI	16.50 kg	
ABERDEEN 1	<b>ABA-20002</b>	24 LED	61 W	7212 - 7996 lm	T2 [142°x59°], T3 [142°x72°], T4 [102°x63°], T5 [119°x147°]	3000K CRI80, 4000K CRI80	On/Off, 1-10V, DALI	16.50 kg	
<b>Top Ø700 - LIGHTCONNECT™</b>									
ABERDEEN 1	<b>ABA-20001-LC</b>	24 LED	45 W	5627 - 6228 lm	T2 [142°x59°], T3 [142°x72°], T4 [102°x63°], T5 [119°x147°]	3000K CRI80, 4000K CRI80	DALI	16.50 kg	
ABERDEEN 1	<b>ABA-20002-LC</b>	24 LED	61 W	7212 - 7996 lm	T2 [142°x59°], T3 [142°x72°], T4 [102°x63°], T5 [119°x147°]	3000K CRI80, 4000K CRI80	DALI	16.50 kg	
<b>Top Ø740</b>									
ABERDEEN 2	<b>ABA-20011</b>	24 LED	45 W	5627 - 6228 lm	T2 [142x59], T3 [142x72], T4 [102x63], T5 [119°x147°]	3000K CRI80, 4000K CRI80	On/Off, 1-10V, DALI	15 kg	

## Accessories

	 NEMA 7 socket <b>A90891</b>	 Zhaga Book 18 socket (Up) <b>A90991-U</b>	 Remote solar charge controller for Solar Integrated Bollards and Vertical Solar PV poles <b>A92691</b>	 DALI Control System <b>Control-DALI</b>
ABA-20001			•	•
ABA-20001-LC	•	•		•
ABA-20002				•
ABA-20002-LC	•	•		•
ABA-20011			•	•

**ABERDEEN**

ABA-20001, ABA-20002

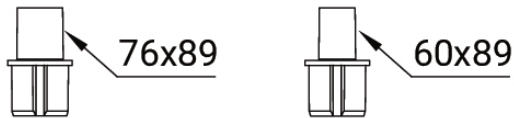
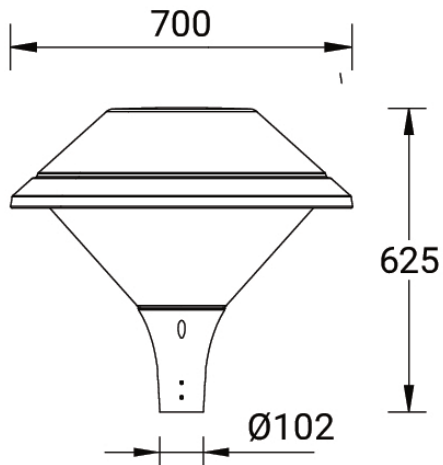

ABA-20011

