

FUNEN

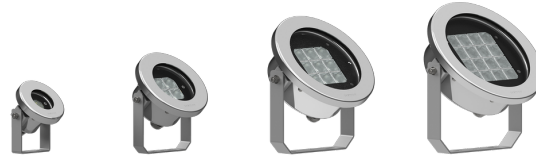

High-performing adjustable underwater spotlight range. The complete professional underwater system offering RGBW options and extensive source and optic combinations.



Luminaire Structure

- Stainless steel body in grade 316
- Single cable entry
- Stainless steel fasteners in grade 316
- Durable silicone rubber gasket
- Clear toughened glass
- Remote driver is included for constant current (CC) products and is not IP-rated
- Remote driver is not included for constant voltage (CV) products
- Remote box IP-rated is not included and is to be ordered separately for constant current (CC) products
- Luminaire must be submerged when operational
- Maximum depth 2 m
- Outdoor cable needs to be ordered with a specific length
- Maximum distance of the Remote DMX/RDM decoder is 8 m

Feature

| | | | |
|-----------|-----------|--------------|---------------|
| LED | | RGBW | 1-10V DIMMING |
| DMX | DMX RDM | NON DIMMABLE | |
| Rotatable | Tilt able | | |

Optic

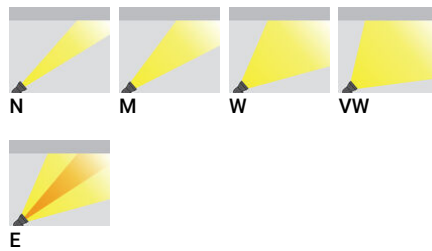

Product colour

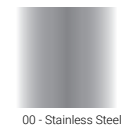

FUNEN

Technical information

| | Model number | Light source | Power | Lumen | Optic | CCT / CRI | Dimming type | Weight | |
|--|------------------|--------------|-------|----------------|--|--------------------------|---------------|--------|--|
| Without remote box IP-rated - With remote driver - Constant current (CC) 1400 mA | | | | | | | | | |
| FUNEN 4 | FUN-50031 | 16 LED | 39 W | 3172 - 4416 lm | N [10°], M [16°], W [32°], VW [71°], E [11°x43°] | 3000K CRI80, 4000K CRI80 | On/Off, 1-10V | 2.4 kg | |
| Without remote box IP-rated - With remote driver - Constant current (CC) 2100 mA | | | | | | | | | |
| FUNEN 3 | FUN-50021 | 9 LED | 23 W | 1923 - 2437 lm | N [11°], M [17°], W [32°], VW [71°], E [14°x43°] | 3000K CRI80, 4000K CRI80 | On/Off, 1-10V | 1.4 kg | |
| Without remote box IP-rated - With remote driver - Constant current (CC) 350 mA | | | | | | | | | |
| FUNEN 1 | FUN-50001 | 1 LED | 6 W | 230 - 408 lm | N [13°], M [18°], W [28°], VW [63°], E [13°x42°] | 3000K CRI80, 4000K CRI80 | On/Off, 1-10V | 0.4 kg | |
| Without remote box IP-rated - With remote driver - Constant current (CC) 800 mA | | | | | | | | | |
| FUNEN 2 | FUN-50011 | 4 LED | 11 W | 798 - 1068 lm | N [11°], M [17°], W [33°], VW [71°], E [11°x41°] | 3000K CRI80, 4000K CRI80 | On/Off, 1-10V | 0.9 kg | |
| Without remote driver - Constant voltage (CV) 24 V | | | | | | | | | |
| FUNEN 1 | FUN-50003 | 1 LED | 4 W | 211 - 358 lm | N [13°], M [18°], W [32°], VW [63°], E [13°x42°] | 3000K CRI80, 4000K CRI80 | On/Off | 0.4 kg | |
| FUNEN 2 | FUN-50013 | 4 LED | 9 W | 762 - 984 lm | N [11°], M [17°], W [30°], VW [71°], E [11°x41°] | 3000K CRI80, 4000K CRI80 | On/Off | 0.9 kg | |
| FUNEN 3 | FUN-50023 | 9 LED | 21 W | 1907 - 2319 lm | N [11°], M [17°], W [32°], VW [71°], E [14°x43°] | 3000K CRI80, 4000K CRI80 | On/Off | 1.4 kg | |
| FUNEN 4 | FUN-50033 | 16 LED | 32 W | 3276 - 4038 lm | N [10°], M [16°], W [32°], VW [71°], E [11°x43°] | 3000K CRI80, 4000K CRI80 | On/Off | 2.4 kg | |
| Without remote driver - Constant voltage (CV) 24 V - RGBW | | | | | | | | | |
| FUNEN 2 | FUN-50012 | 4 LED | 10 W | 395 - 520 lm | N [13°], M [19°], W [32°], VW [71°], E [13°x42°] | RGBW30, RGBW40 | DMX, DMX/RDM | 0.9 kg | |
| FUNEN 3 | FUN-50022 | 8 LED | 15 W | 853 - 1133 lm | N [11°], M [17°], W [32°], VW [71°], E [14°x43°] | RGBW30, RGBW40 | DMX, DMX/RDM | 1.4 kg | |
| FUNEN 4 | FUN-50032 | 16 LED | 20 W | 1444 - 1929 lm | N [8°], M [17°], W [26°], VW [65°], E [43°x11°] | RGBW30, RGBW40 | DMX, DMX/RDM | 2.4 kg | |
| Without remote driver - With remote DMX/RDM decoder - Constant voltage (CV) 24 V - RGBW | | | | | | | | | |
| FUNEN 1 | FUN-50002 | 1 LED | 4 W | 170 lm | M [34°] | RGBW30, RGBW40 | DMX, DMX/RDM | 0.4 kg | |

Accessory

We reserve the right to make technical and design changes.







07:06, 13-04-2026







<https://www.ligman.com/funen-underwater-projectors-floodlight-s-fun-un3/>

THAILAND

LIGMAN Lighting Co.,Ltd.
17/2 Moo 4, Monthong, Bang Nam Prioa,
24150 Chachoengsao - Thailand
info@ligman.com

FUNEN

| |  Driver (CV) - On/Off - 36 W - IP67 - 24 V A34491-ND |  Driver (CV) - On/Off - 60 W - IP67 - 24 V A34591-ND |  Driver (CV) - On/Off - 100 W - IP67 - 24 V A34791-ND |  Driver (CV) - On/Off - 150 W - IP67 - 24 V A34891-ND |  Driver (CV) - On/Off - 200 W - IP67 - 24 V A34991-ND |  Driver (CV) - On/Off - 350 W - IP67 - 24 V A35091-ND |  Honeycomb louvre A52221 |
|-----------|--|--|---|---|---|---|--|
| FUN-50001 | | | | | | | • |
| FUN-50002 | • | • | • | • | • | • | • |
| FUN-50003 | • | • | • | • | • | • | • |
| FUN-50011 | | | | | | | |
| FUN-50012 | • | • | • | • | • | • | |
| FUN-50013 | • | • | • | • | • | • | |
| FUN-50021 | | | | | | | |
| FUN-50022 | • | • | • | • | • | • | |
| FUN-50023 | • | • | • | • | • | • | |
| FUN-50031 | | | | | | | |
| FUN-50032 | • | • | • | • | • | • | |
| FUN-50033 | • | • | • | • | • | • | |

| |  Honeycomb louvre A52321 |  Honeycomb louvre A52421 |  Honeycomb louvre A52521 |  Remote box IP65 A61851 |  Remote box IP65 A80191 |  Remote box IP65 A80291 |  DMX Control System Control-DMX |
|-----------|--|--|--|---|---|---|--|
| FUN-50001 | | | | | • | | |
| FUN-50002 | | | | | | | • |
| FUN-50003 | | | | | | | |
| FUN-50011 | • | | | | • | | |
| FUN-50012 | • | | | | | | • |
| FUN-50013 | • | | | | | | |
| FUN-50021 | | • | | | | • | |
| FUN-50022 | | • | | | | | • |
| FUN-50023 | | • | | | | | |
| FUN-50031 | | | • | • | | | |
| FUN-50032 | | | • | | | | • |
| FUN-50033 | | | • | | | | |

| |  DMX/RDM Control System Control-DMX- RDM |
|-----------|---|
| FUN-50001 | |
| FUN-50002 | • |
| FUN-50003 | |
| FUN-50011 | |
| FUN-50012 | • |
| FUN-50013 | |
| FUN-50021 | |
| FUN-50022 | • |
| FUN-50023 | |
| FUN-50031 | |
| FUN-50032 | • |
| FUN-50033 | |

FUNEN

FUN-50001, FUN-50002, FUN-50003

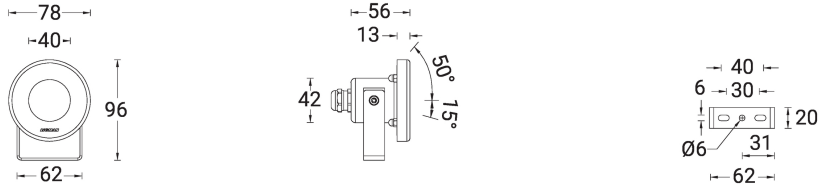

FUN-50011, FUN-50012, FUN-50013

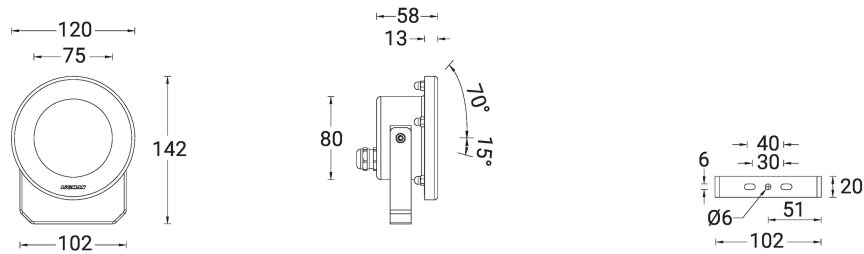

FUN-50021, FUN-50022, FUN-50023

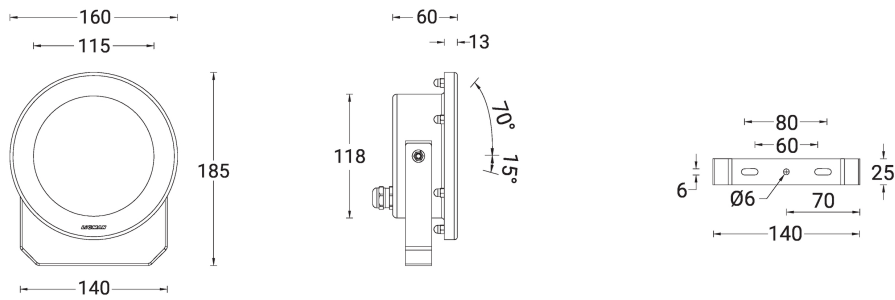

FUN-50031, FUN-50032, FUN-50033

