

QUANTUM



Compact and powerful gobo projector, aluminium powder coated housing with IP66 protection. Three optional forward-lens focal lengths. Accepts both metal and glass standard size-M gobos.



Luminaire Structure

- Die-cast aluminium housing
- Pre-treated before powder coating ensuring high corrosion resistance
- Single cable entry
- Stainless steel fasteners in grade 304 with zinc flake coating (ZFC)
- Durable silicone rubber gasket
- Internal rear collimating lens
- Three optional forward-lens focal lengths
- High-efficiency optical reflector
- Clear toughened glass
- Integral control gear
- Arm mounting installation
- Gobo holder (suitable for metal or glass gobos)
- Takes standard Size-M gobos

Feature



Optic

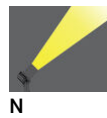

Product colour

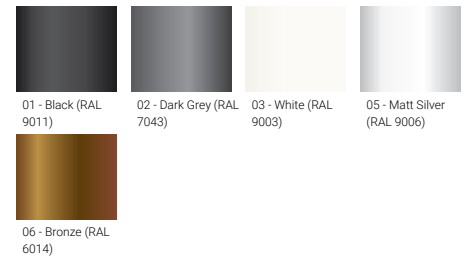

Special finishes upon request

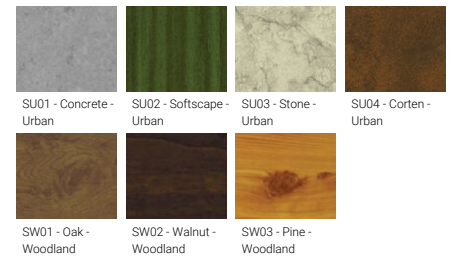













QUANTUM

Technical information

	Model number	Light source	Power	Lumen	Optic	CCT / CRI	Dimming type	Weight
Gobo projector								
QUANTUM 1-G	QA-50031	1 COB	44 W	2376 - 2508 lm	N [17°]	3000K CRI80, 4000K CRI80	On/Off, DALI	6.0 kg

Accessories

						
CUSTOM - Black & White - Glass gobo - M Size A55021	CUSTOM - Gray scale - Glass gobo - M Size A55121	CUSTOM - 1 colour - Glass gobo - M Size A55221	CUSTOM - 3 colours - Glass gobo - M Size A55421	CUSTOM - 4 colours - Glass gobo - M Size A55521	Leaves - Glass gobo - M Size A56421	Tropical leaves - Glass gobo - M Size A56521
QA-50031

					
Branches - Glass gobo - M Size A56621	Water - Glass gobo - M Size A56721	Clouds - Glass gobo - M Size A56821	Moon - Glass gobo - M Size A56921	Window - Glass gobo - M Size A57021	City - Glass gobo - M Size A57121
QA-50031

QA-50031

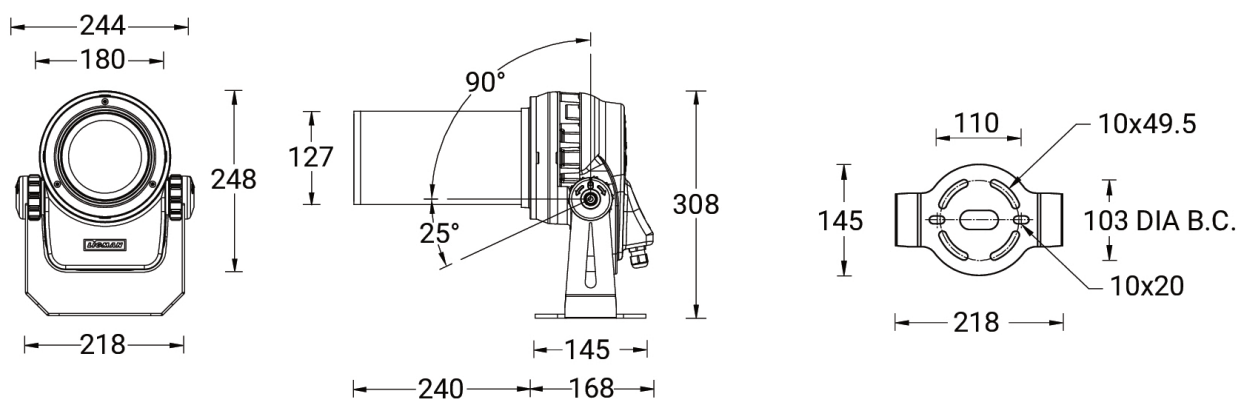

QUANTUM

QUANTUM
Floodlights, projectors

Adjustable surface-mounted technical projectors. New large premium projector, extending the family with stylish modern design, unique rotary thermal guard and up to 27,000 delivered lumens.

<https://www.ligman.com/quantum-floodlights-projectors-qu-pr3/>



QUANTUM
Cluster column projectors

Adjustable column technical projector cluster solution. Flexible technical project solutions in attractive cluster arrangements using the stylish premium QUANTUM projectors.

<https://www.ligman.com/quantum-cluster-column-projectors-qua-pr3/>



QUANTUM
Street & area lighting luminaires

Adjustable column-mounted technical projector solution. Flexible technical project solutions in attractive column-downlight using the stylish premium QUANTUM projectors.

<https://www.ligman.com/quantum-street-area-lighting-luminaires-qu-st3/>