

# SYNDY



**Indirect mirror-reflector post top.**  
**Technically precise indirect ambient lighting**  
**using faceted mirror reflectors atop elegant**  
**columns with concealed uplight.**



## Luminaire Structure

- Die-cast aluminium housing
- Pre-treated before powder coating ensuring high corrosion resistance
- Extruded aluminium column
- Stainless steel fasteners in grade 304 with zinc flake coating (ZFC)
- Durable silicone rubber gasket
- Clear toughened glass
- Aluminium parabolic reflector on the top of luminaire
- Integral control gear installed under spigot pole
- Maximum wind load resistance is 120 km/h

## Feature

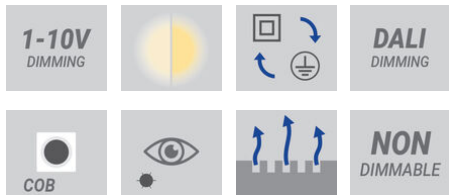

## Optic

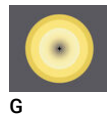

## Product colour

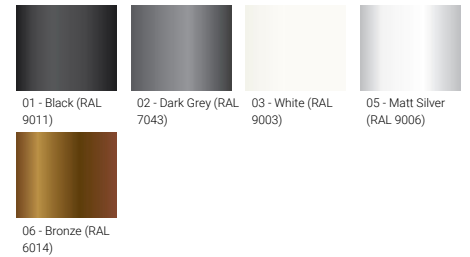

## Special finishes upon request

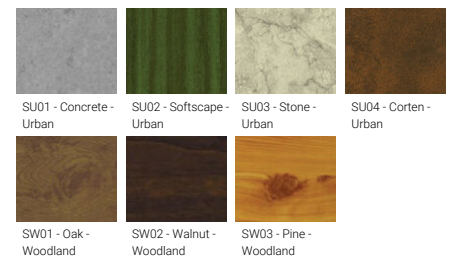

# SYNDY

## Technical information

	Model number	Light source	Power	Lumen	Optic	CCT / CRI	Dimming type	Weight	
<b>Oval - Supplied with a cylindrical, straight aluminium pole - Height options: 3 - 6 m</b>									
	SYNDY 1	<b>SY-20643</b>	1 COB	40 W	2322 - 2351 lm	G [110°x 122°]	3000K, 4000K	On/Off, 1-10V, DALI	23.2 kg
	SYNDY 1	<b>SY-20644</b>	1 COB	55 W	2944 - 3150 lm	G [110°x 122°]	3000K, 4000K	On/Off, 1-10V, DALI	23.2 kg
<b>Oval - Supplied with a cylindrical, straight aluminium pole - Height options: 4 - 6 m</b>									
	SYNDY 2	<b>SY-20913</b>	1 COB	39 W	1986 - 2491 lm	G [122°x 120°]	3000K, 4000K	On/Off, 1-10V, DALI	34.6 kg
	SYNDY 2	<b>SY-20914</b>	1 COB	49 W	2329 - 2922 lm	G [122°x 120°]	3000K CRI80, 4000K CRI80	On/Off, 1-10V, DALI	34.6 kg
<b>Round - Supplied with a cylindrical, straight aluminium pole - Height options: 3 - 6 m</b>									
	SYNDY 3	<b>SY-20931</b>	1 COB	40 W	2300 - 2328 lm	G [120°x 123°]	3000K, 4000K	On/Off, 1-10V, DALI	26.0 kg
	SYNDY 3	<b>SY-20932</b>	1 COB	55 W	2933 - 3139 lm	G [118°x 122°]	3000K, 4000K	On/Off, 1-10V, DALI	26.0 kg
<b>Round - Supplied with a cylindrical, straight aluminium pole - Height options: 4 - 6 m</b>									
	SYNDY 4	<b>SY-21093</b>	1 COB	39 W	2221 - 2787 lm	G [52°x 55°]	3000K, 4000K	On/Off, 1-10V, DALI	31.1 kg
	SYNDY 4	<b>SY-21094</b>	1 COB	49 W	2605 - 3269 lm	G [52°x 55°]	3000K, 4000K	On/Off, 1-10V, DALI	31.1 kg

## Accessories

	Root mount kit <b>A20491</b>	Root mount kit <b>A20691</b>	Circuit breaker box IP44 <b>A21291</b>	3 m - Cylindrical, straight aluminium pole for SYNDY, ANESTI <b>APD130102-ASP</b>	4 m - Cylindrical, straight aluminium pole for SYNDY, ANESTI <b>APD140102-ASP</b>	4 m - Cylindrical, straight aluminium pole for SYNDY <b>APD140140-SYNDY</b>	5 m - Cylindrical, straight aluminium pole for SYNDY, ANESTI, ARGENTINA <b>APD150127-ASP</b>
SY-20643	•	•	•	•	•		•
SY-20644	•	•	•		•		•
SY-20913		•	•			•	
SY-20914		•	•			•	
SY-20931	•	•	•	•	•		•
SY-20932	•	•	•	•	•		•
SY-21093		•	•			•	
SY-21094		•	•			•	

	5 m - Cylindrical, straight aluminium pole for SYNDY <b>APD150140- SYNDY</b>	6 m - Cylindrical, straight aluminium pole for SYNDY, ANESTI, ARGENTINA <b>APD160127- ASP</b>	6 m - Cylindrical, straight aluminium pole for SYNDY <b>APD160140- SYNDY</b>	 DALI Control System <b>Control-DALI</b>
SY-20643		•		•
SY-20644		•		•
SY-20913	•		•	•
SY-20914	•		•	•
SY-20931		•		•
SY-20932		•		•
SY-21093	•		•	•
SY-21094	•		•	•

**SYNDY**

SY-20643, SY-20644

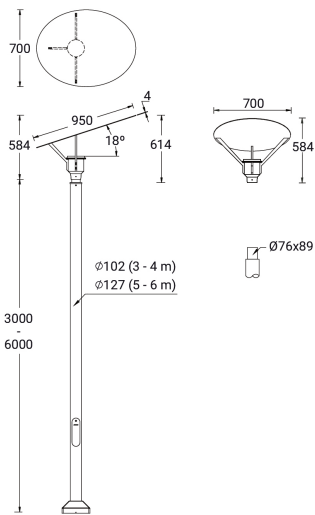

SY-20913, SY-20914

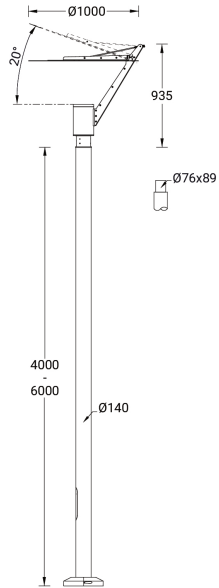

SY-20931, SY-20932

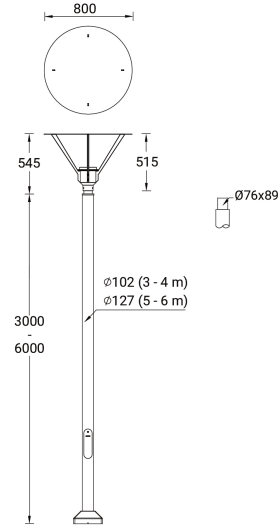

SY-21093, SY-21094

