

# TANGO

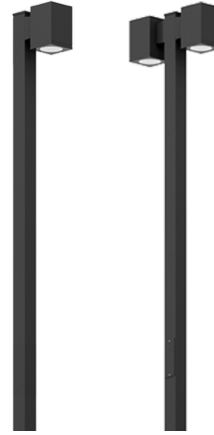

Square form technical light column range. Flexible light column lighting solutions for perfect symmetrical or asymmetrical task lighting.



## Luminaire Structure

- Die-cast aluminium housing and frame
- Pre-treated before powder coating ensuring high corrosion resistance
- Stainless steel fasteners in grade 304 with zinc flake coating (ZFC)
- Durable silicone rubber gasket
- High-efficiency PMMA lens
- Clear toughened glass
- Maximum wind load resistance is 140 km/h
- Available without pole upon request

## Feature

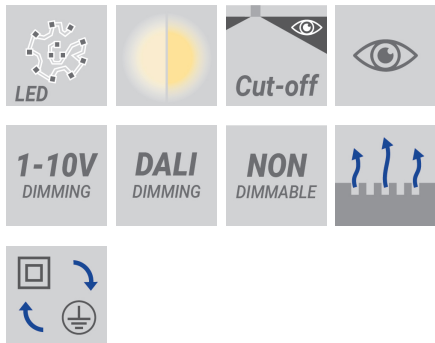

## Optic



## Product colour

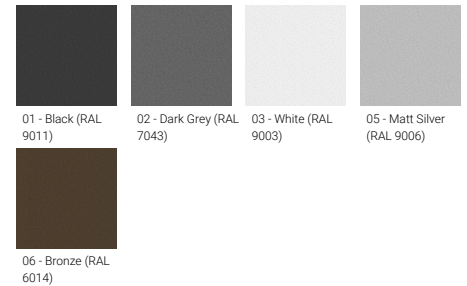

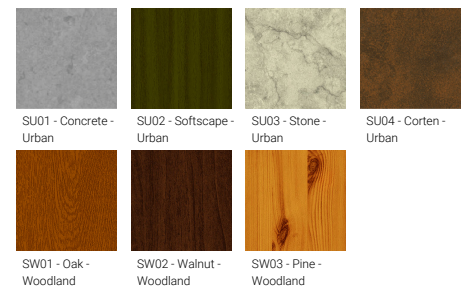

## Special finishes upon request





# TANGO

## Technical information

	Model number	Light source	Power	Lumen	Optic	CCT / CRI	Dimming type	Weight	
<b>1 side - Square - Supplied with specific 3 m square, straight aluminium pole: APC130102-TA-20731</b>									
TANGO 35	<b>TA-20731</b>	16 LED	35 W	3476 - 3763 lm	T2 [138°x43°], T3 [147°x78°], T4 [11°x80°]	3000K CRI80, 4000K CRI80	On/Off, 1-10V, DALI	20.4 kg	
<b>2 sides - Square - Supplied with specific 3 m square, straight aluminium pole: APC230102-TA-20732</b>									
TANGO 35	<b>TA-20732</b>	16 & 16 LED	70 W	6952 - 7526 lm	T2 [138°x43°], T3 [147°x78°], T4 [11°x80°]	3000K CRI80, 4000K CRI80	On/Off, 1-10V, DALI	26.7 kg	

## Accessory

	 Root mount kit <b>A20491</b>	 Circuit breaker box IP44 <b>A21291</b>	 DALI Control System <b>Control-DALI</b>
TA-20731	•	•	•
TA-20732	•	•	•

**TANGO**

TA-20731

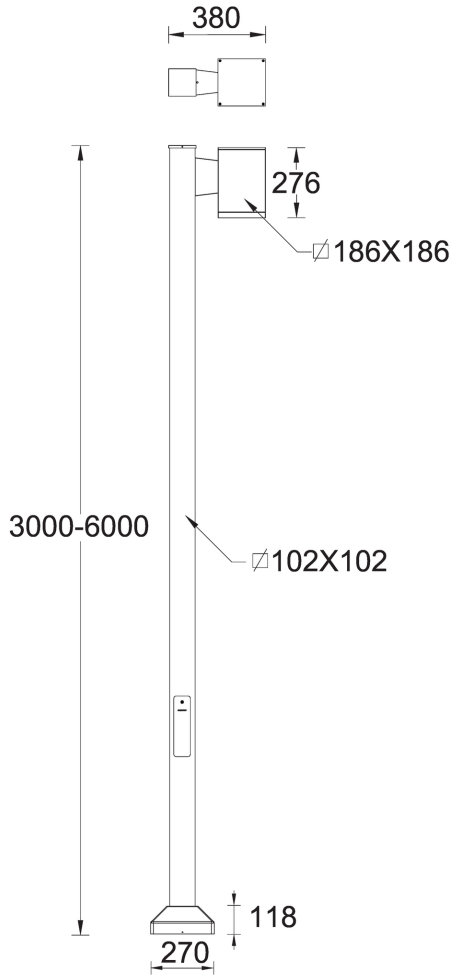

TA-20732

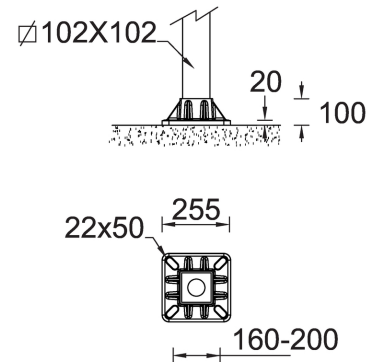
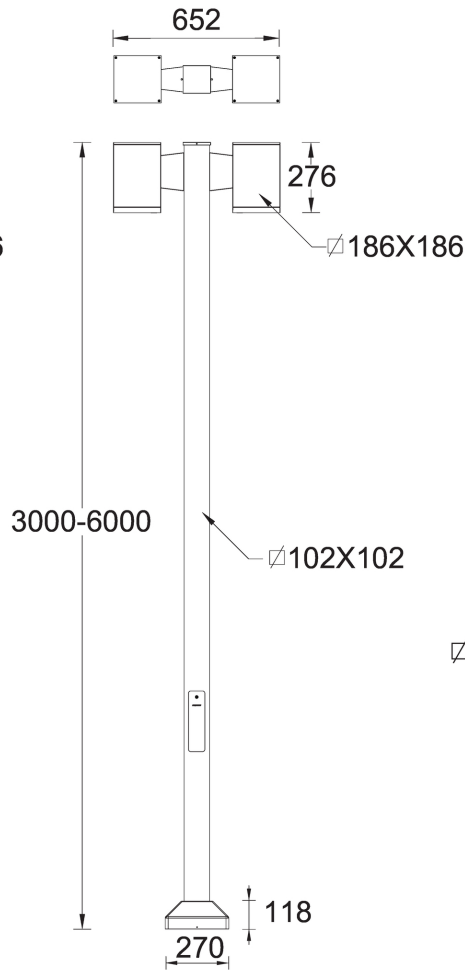

**TANGO**

---

TANGO  
**Surface exterior downlights**

---

Circular or square form technical surface-ceiling downlight range. Completely tailorable ceiling-mounted optical lighting solutions for perfect task or architectural lighting.

<https://www.ligman.com/tango-surface-external-downlights-ta-ce3/>



---

TANGO  
**Surface facade luminaires**

---

Circular or square form technical up & downlight wall range. Completely tailorable wall-mounted direct/indirect optical lighting solutions for perfect task or architectural lighting.

<https://www.ligman.com/tango-surface-facade-luminaires-ta-su3/>



---

TANGO  
**Post top luminaires**

---

Square or circular form technical post top range. Flexible post top lighting solutions for perfect symmetrical or asymmetrical task lighting.

<https://www.ligman.com/tango-post-top-luminaires-ta-po3/>