

TAURAS



Plain, tranquil and secure column family.
Pleasing, comfortable column choices with soft distributions and many options to fashion to project needs.



Luminaire Structure

- Die-cast aluminium housing
- Extruded aluminium column
- Pre-treated before powder coating ensuring high corrosion resistance
- Stainless steel fasteners in grade 304 with zinc flake coating (ZFC)
- Durable silicone rubber gasket
- Clear UV-stabilised polycarbonate diffuser
- Mat finishing aluminium reflector
- Maximum wind load resistance is 160 km/h
- Surge protection 10kV

Feature

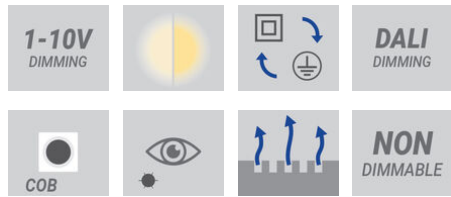

Optic

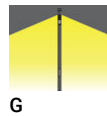

Product colour

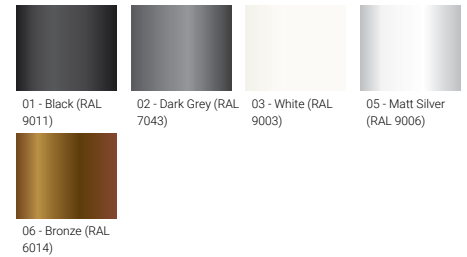

Special finishes upon request

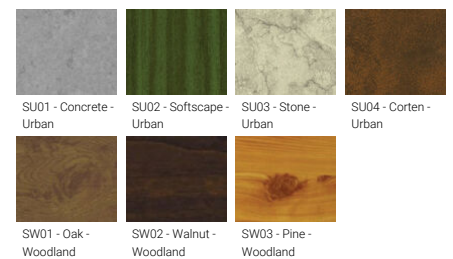





TAURAS

Technical information

	Model number	Light source	Power	Lumen	Optic	CCT / CRI	Dimming type	Weight
Ø160 mm - Supplied with specific 2.5 m cylindrical, straight aluminium pole: APD125160-TU-20396-1								
TAURAS 3	TU-20396-1	1 COB	41 W	1082 - 1096 lm	G [172°]	3000K CRI80, 4000K CRI80	On/Off, 1-10V, DALI	32.6 kg
Ø160 mm - Supplied with specific 2.5 m cylindrical, straight aluminium pole: APD125160-TU-20396-2								
TAURAS 3	TU-20396-2	1 COB	41 W	1082 - 1096 lm	G [172°]	3000K CRI80, 4000K CRI80	On/Off, 1-10V, DALI	32.6 kg

Accessories

	 Root mount kit A20691	 Circuit breaker box IP44 A21291	 2.5 m - Cylindrical, straight aluminium pole for TAURAS APD125160- TU-20396-1	 2.5 m - Cylindrical, straight aluminium pole for TAURAS APD125160- TU-20396-2	 DALI Control System Control-DALI
TU-20396-1	•	•	•		•
TU-20396-2	•	•		•	•

TAURAS

TU-20396-1
TU-20396-2

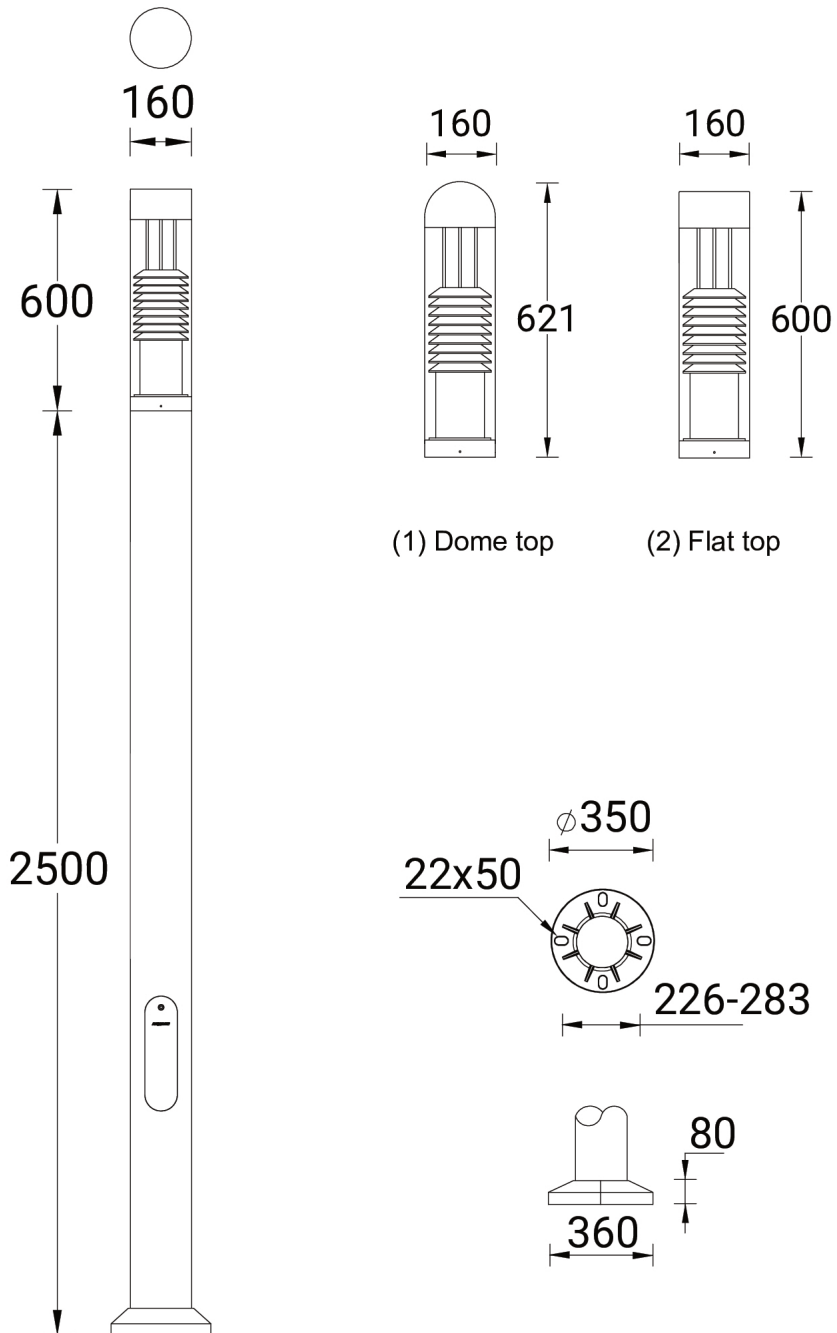

TAURAS



TAURAS
Bollards

Plain, tranquil and secure bollard family. Pleasing, comfortable bollard choices with soft distributions and many options to fashion to project needs.

<https://www.ligman.com/tauras-bollards-ta-bo3/>