

UTAH



Miniature adjustable projector range. Contemporary simplicity and a diminutive footprint allows designers to paint landscaping with light whilst avoiding visual clutter.



Luminaire Structure

- Die-cast aluminium housing
- Pre-treated before powder coating ensuring high corrosion resistance
- Single cable entry
- Stainless steel fasteners in grade 304 with zinc flake coating (ZFC)
- Durable silicone rubber gasket
- High-efficiency PMMA lens
- Clear toughened glass
- Integral control gear for UTAH ECO 1
- Remote driver is not included for constant current (CC) products
- Remote driver is not included for constant voltage (CV) products
- Plastic ground spike for garden type

Feature

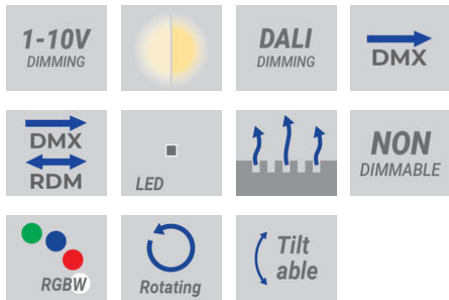

Optic

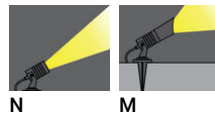

Product colour

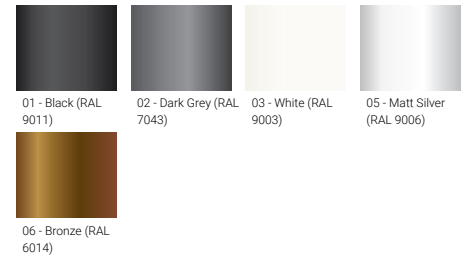



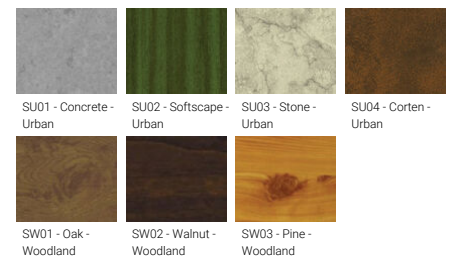



Special finishes upon request

















UTAH

Technical information

	Model number	Light source	Power	Lumen	Optic	CCT / CRI	Dimming type	Weight	
Integral control gear - With spike / anti-glare visor - Class I									
	UTAH ECO 1	UT-50571	1 LED	6 W	356 - 374 lm	M [24°]	3000K CRI80, 4000K CRI80	On/Off	0.27 kg.
Without remote driver - Constant current (CC) 500 mA - Class III									
	UTAH 1	UT-50553	1 LED	2 W	191 - 201 lm	N [22°]	3000K CRI80, 4000K CRI80	On/Off, 1-10V, DALI	0.27 kg. 
Without remote driver - Constant voltage (CV) 24V - Class III									
	UTAH 1	UT-50552	1 LED	2 W	191 - 201 lm	N [22°]	3000K CRI80, 4000K CRI80	On/Off	0.27 kg. 
Without remote driver - Constant voltage (CV) 24V - Class III - RGBW									
	UTAH 3	UT-50555	1 LED	5 W	224 lm	M [33°]	RGBW30, RGBW40	DMX, DMX/RDM	0.27 kg. 
Without remote driver - With spike - Constant current (CC) 500 mA - Class III									
	UTAH 2	UT-50563	1 LED	2 W	191 - 201 lm	N [22°]	3000K CRI80, 4000K CRI80	On/Off	0.27 kg. 
Without remote driver - With spike - Constant voltage (CV) 24 V - Class III									
	UTAH 2	UT-50562	1 LED	2 W	191 - 201 lm	N [22°]	3000K CRI80, 4000K CRI80	On/Off	0.27 kg. 
Without remote driver - With spike - Constant voltage (CV) 24 V - Class III - RGBW									
	UTAH 4	UT-50565	1 LED	5 W	224 lm	M [33°]	RGBW30, RGBW40	DMX, DMX/RDM	0.27 kg. 

Accessories

	 Driver (CC) - DALI - 20 W - IP20 - 700 mA max A32691-DA	 Driver (CC) - 1-10V - 20 W - IP20 - 700 mA max A32691-DI	 Driver (CC) - On/Off - 20 W - IP20 - 700 mA max A32691-ND	 Driver (CV) - On/Off - 36 W - IP67 - 24 V A34491-ND	 Driver (CV) - On/Off - 60 W - IP67 - 24 V A34591-ND	 Driver (CV) - On/Off - 100 W - IP67 - 24 V A34791-ND	 Driver (CV) - On/Off - 150 W - IP67 - 24 V A34891-ND
UT-50552			
UT-50553	.	.	.				
UT-50555			
UT-50562			
UT-50563	.	.	.				
UT-50565			
UT-50571							

	 Driver (CV) - On/Off - 200 W - IP67 - 24 V A34991-ND	 Driver (CV) - On/Off - 350 W - IP67 - 24 V A35091-ND	 Anti-glare visor A51431	 Remote box IP65 A80191	 DALI Control System Control-DALI	 DMX Control System Control-DMX	 DMX/RDM Control System Control-DMX-RDM
UT-50552	.	.	.				
UT-50553				.	.		
UT-50555
UT-50562	.	.	.				
UT-50563				.	.		

UTAH

UT-50565

UT-50571

UTAH

UT-50552, UT-50553
UT-50555

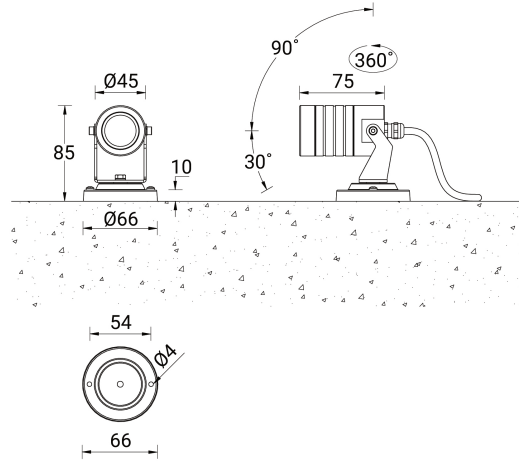

UT-50562, UT-50563
UT-50565

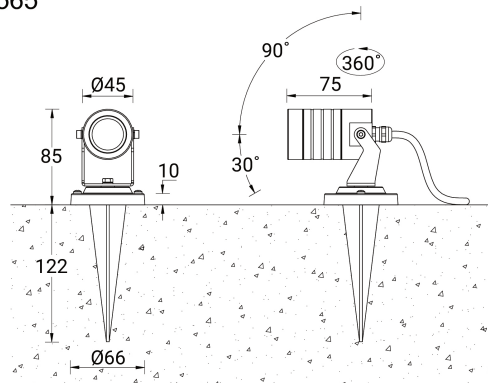

UT-50571, UT-50572

