

Driver ND - 100 W - IP20 - Constant voltage - 24 V (A32291-ND)

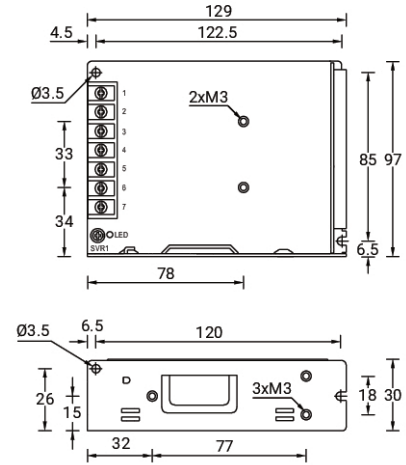

A32291



Product description

Technical information

Store code: LTT0100007