

ARDEN 4 (ARD-90133)



Product description

Down (Optic) & Up (Optic 2nd) - 600 mm - TW



Luminaire Structure

- Extruded aluminium bended profile with powder coating
- Stainless steel fasteners in grade 316
- Stainless steel, adjustable, suspension (1.5 m) complete with electrical wires in white for mounting
- PMMA diffuser with Opal (UGR <19) and micro prismatic (UGR <13) options for better glare control

- Up and down light distribution options
- Passive thermal management
- Integral control gear
- Wireless control available through Bluetooth connection

- Daylight and occupancy sensor options
- Emergency module (1 or 3 hours) is available upon request with 3 options (BASIC, SELF-TEST, PRO-DALI)

Product colour



01 - Black (RAL 9011) 03 - White (RAL 9003) 05 - Matt Silver (RAL 9006)

Special finishes upon request

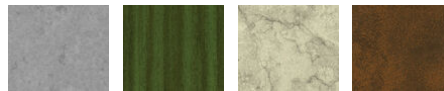

SU01 - Concrete - Urban SU02 - Softscape - Urban SU03 - Stone - Urban SU04 - Corten - Urban



SW01 - Oak - Woodland SW02 - Walnut - Woodland SW03 - Pine - Woodland

ARDEN 4 (ARD-90133)

Technical information

Material	Aluminium	Optic value	108°, 96°	Lens / Reflector / Optic	PMMA diffuser with Opal (UGR <19) and micro prismatic (UGR <13) options for better glare control
Light source	1344 & 480 LED	Optic (2nd)	0	MacAdam Ellipse	3 SDCM
Power	91 W	Optic (2nd) value	105°	Lifetime L90B10 (hours)	> 23,000
Lumen	15517 lm	CCT / CRI	TW (2700K - 6500K)	Lifetime L80B10 (hours)	> 45,000
Driver option	Integral control gear	Dimming type	DALI	Lifetime L80B50 (hours)	> 50,000
Driver	Constant current (CC)	Product colours	Black, White, Matt Silver, Concrete - Urban, Softscape - Urban, Stone - Urban, Corten - Urban, Oak - Woodland, Walnut - Woodland, Pine - Woodland	Variants (DALI)	Compatible with EN/ IEC 60598-2-22: Suitable for emergency installations as central supply, non-maintained (Z0)
Input voltage	220-240 V 50/60 Hz				
Optic	O, P	Weight	6.5 kg		
		Operating temperature	-20 °C to 40 °C		

ARD-90133

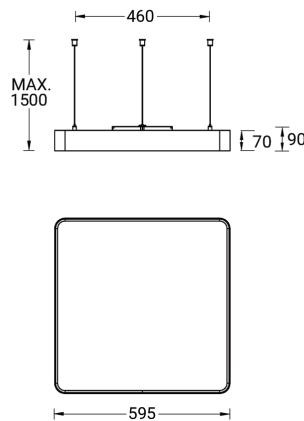

Accessories

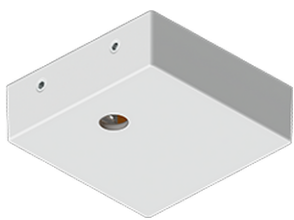

Supply cable surface mounting box
A80981

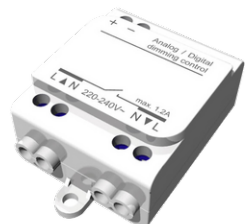

Wireless bluetooth converter
A90291



Xpress wireless switch
A90591

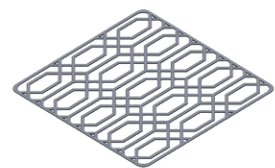

Decorative pattern - Type A for ARDEN 600 mm.
A91721

ARDEN 4 (ARD-90133)

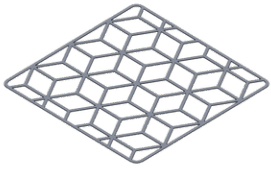

Decorative pattern - Type B for
ARDEN 600 mm
A93121

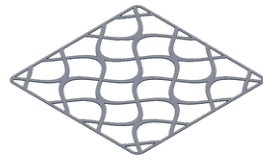

Decorative pattern - Type C for
ARDEN for ARDEN 600 mm
A94521



DALI Control System
Control-DALI
