

BILLUND 3 (BIU-90022)



Product description

Large



Luminaire Structure

- Die-cast aluminium housing
- Pre-treated before powder coating ensuring high corrosion resistance
- Thermal heat dissipation body
- Single cable entry
- One IP68 connector supplied with 0.3 m of 3x1.0 sqmm outdoor cable

- Stainless steel fasteners in grade 304 with zinc flake coating (ZFC)
- Durable silicone rubber gasket
- Clear toughened glass
- High-efficiency polycarbonate lens
- Integral control gear

- Surge protection 10kV
- Constant lumen output (CLO) and Night-time dimming options

Optic



T1 T2 T3 T4

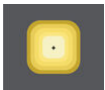

T5

Product colour



01 - Black (RAL 9011) 02 - Dark Grey (RAL 7043) 03 - White (RAL 9003) 05 - Matt Silver (RAL 9006)



06 - Bronze (RAL 6014)

Special finishes upon request

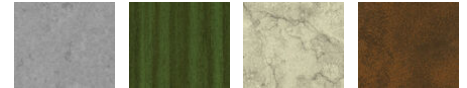

SU01 - Concrete - Urban SU02 - Softscape - Urban SU03 - Stone - Urban SU04 - Corten - Urban



SW01 - Oak - Woodland



SW02 - Walnut - Woodland

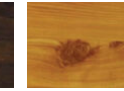

SW03 - Pine - Woodland

BILLUND 3 (BIU-90022)

Technical information

Material	Aluminium	Optic	T1, T2, T3, T4, T5	Product colours	Black, Dark Grey, White, Matt Silver, Bronze, Concrete - Urban, Softscape - Urban, Stone - Urban, Corten - Urban, Oak - Woodland, Walnut - Woodland, Pine - Woodland
Light source	96 LED	Optic value	146°x100°, 138°x125°, 140°x63°, 133°x66°, 111°x65°, 92°x121°	Weight	14.3 kg
Power	174 W	CCT / CRI	3000K CRI70, 4000K CRI70	Operating temperature	-20 °C to 50 °C
Lumen	21118 - 26426 lm	Bug	B3-U0-G3, B4-U0-G4, B5-U0-G1	Cable	One IP68 connector supplied with 0.3 m of 3x1.0 sqmm outdoor cable
Efficacy	121 - 152 lm/W	ULR	0%	Through wiring	Single cable entry
Driver option	Integral control gear	ULOR	0%	Lens / Reflector / Optic	Clear toughened glass, High-efficiency polycarbonate lens
Driver	Constant current (CC)	CIE flux code n°3	100, 95, 96, 97, 98	Variants (On/Off, 1-10V, DALI)	Compatible with EN/ IEC 60598-2-22: Suitable for emergency installations as central supply, non-maintained (Z0)
Input voltage	220-240 V 50/60 Hz	Dimming type	On/Off, 1-10V, DALI		

BIU-90022

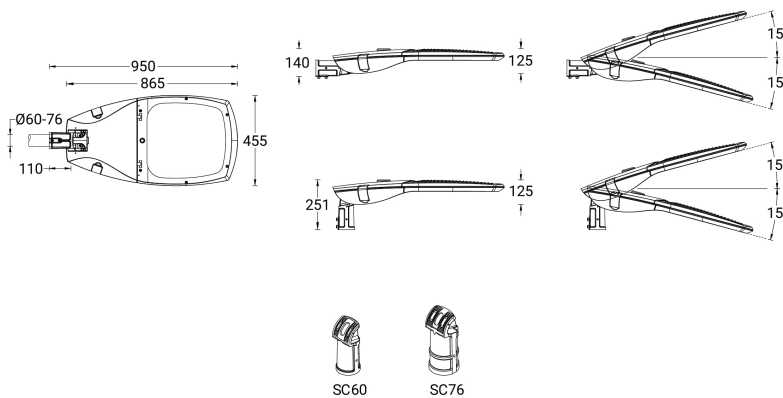

Accessories



DALI Control System
Control-DALI