

EURASIA 1 (EU-10016-2)



Product description

Ø114 - 941 mm - Flat top with shade



microPrim™

Luminaire Structure

- Die-cast aluminium housing
- Extruded aluminium column
- Pre-treated before powder coating ensuring high corrosion resistance
- Single cable entry
- Stainless steel fasteners in grade 304 with zinc flake coating (ZFC)
- Durable silicone rubber gasket
- Sandblast finishing aluminium reflector
- Clear UV-stabilised polycarbonate diffuser
- Integral control gear

Optic



G

Product colour

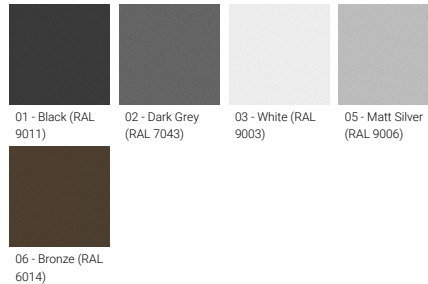

Special finishes upon request

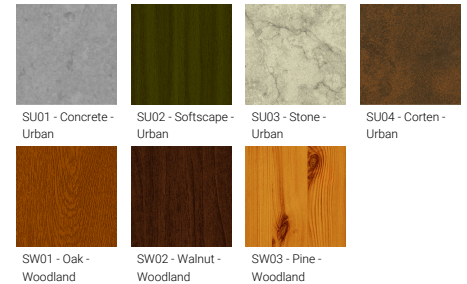

EURASIA 1 (EU-10016-2)

Technical information

Material	Aluminium
Light source	1 COB
Power	41 W
Lumen	979 - 991 lm
Efficacy	24 lm/W
Driver option	Integral control gear
Driver	Constant current (CC)
Input voltage	220-240 V 50/60 Hz

Optic	G
Optic value	360°
CCT / CRI	3000K CRI80, 4000K CRI80
Bug	B1-U3-G1
ULR	20%
ULOR	20%
CIE flux code n°3	78
Dimming type	On/Off, 1-10V, DALI

Product colours	Black, Dark Grey, White, Matt Silver, Bronze, Concrete - Urban, Softscape - Urban, Stone - Urban, Corten - Urban, Oak - Woodland, Walnut - Woodland, Pine - Woodland
Weight	11.0 kg
Operating temperature	-20 °C to 40 °C
Through wiring	Single cable entry
Lens / Reflector / Optic	Sandblast finishing aluminium reflector, Clear UV-stabilised polycarbonate diffuser
MacAdam Ellipse	3 SDCM
Lifetime L90B10 (hours)	> 55,000
Variants (1-10V, DALI)	Compatible with EN/ IEC 60598-2-22: Suitable for emergency installations as central supply, non-maintained (Z0)

EU-10016-2

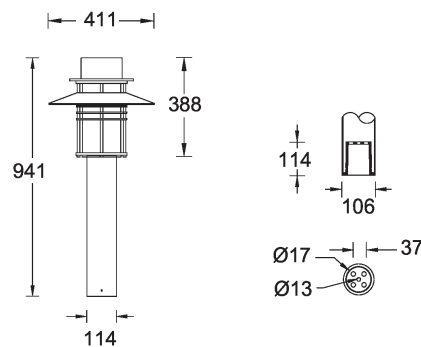

EURASIA 1 (EU-10016-2)**Accessory**



Anchor bolt
A10191



DALI Control System
Control-DALI