

GAVLE 1 (GAV-80062)

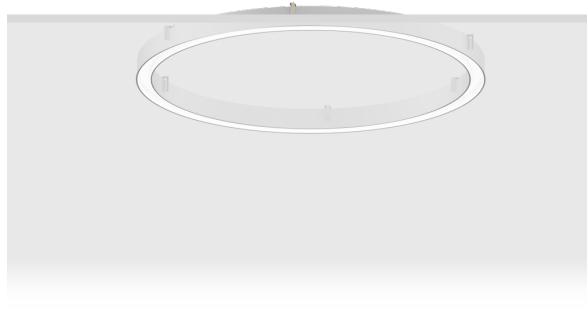

Product description

Down - 70x90 mm - 4000 mm - TW



Luminaire Structure

- Extruded aluminium bended profile with powder coating
- Stainless steel fasteners in grade 316
- Stainless steel brackets and screws for mounting
- Opal PMMA diffuser (UGR <19) for glare control

- Up and down light distribution options
- Passive thermal management
- Integral control gear
- Remote driver is included for dimming type: 1-10V (-DI) for GAV-80001, GAV-80011, GAV-80021, GAV-80031, GAV-80041, GAV-80051, GAV-80061, GAV-80071

- Wireless control available through Bluetooth connection
- Daylight and occupancy sensor options

Optic

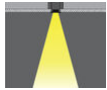

0

Product colour



01 - Black (RAL 9011) 03 - White (RAL 9003) 05 - Matt Silver (RAL 9006)

Special finishes upon request

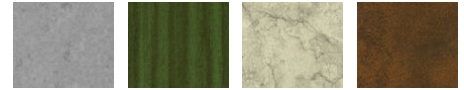

SU01 - Concrete - Urban SU02 - Softscape - Urban SU03 - Stone - Urban SU04 - Corten - Urban



SW01 - Oak - Woodland SW02 - Walnut - Woodland SW03 - Pine - Woodland

GAVLE 1 (GAV-80062)

Technical information

Material	Aluminium	Driver	Constant current (CC)	Product colours	Black, White, Matt Silver, Concrete - Urban, Softscape - Urban, Stone - Urban, Corten - Urban, Oak - Woodland, Walnut - Woodland, Pine - Woodland
Light source	3072 LED	Input voltage	220-240 V 50/60 Hz	Weight	27.2 kg
Power	206 W	Optic	0	Operating temperature	-20 °C to 40 °C
Lumen	21072 lm	Optic value	102°	Variants (DALI)	Compatible with EN/ IEC 60598-2-22: Suitable for emergency installations as central supply, non-maintained (Z0)
Efficacy	102 lm/W	CCT / CRI	TW (2700K - 6500K)		
Driver option	Integral control gear	Dimming type	DALI		

GAV-80062

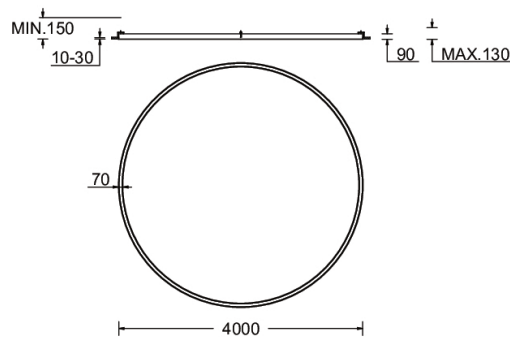

Accessories



Xpress wireless switch
A90591



Wireless bluetooth converter
A90291



DALI Control System
Control-DALI