

GAVLE 5 (GAV-90162)

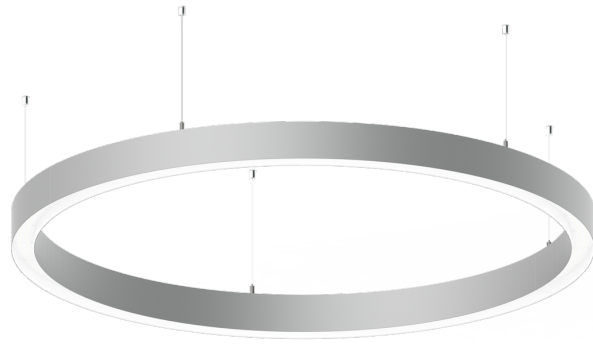

Product description

Down (Optic) & Up (Optic 2nd) - 60x100 mm - 4000 mm - TW



Luminaire Structure

- Extruded aluminium bended profile with powder coating
- Stainless steel fasteners in grade 316
- Stainless steel, adjustable, suspension (1.5 m) complete with electrical wires in white for mounting
- Opal PMMA diffuser (UGR <19) for glare control

- Up and down light distribution options
- Passive thermal management
- Integral control gear
- Remote driver is included for dimming type: 1-10V (-DI) for GAV-90001, GAV-90011, GAV-90021, GAV-90031, GAV-90041, GAV-90051, GAV-90061, GAV-90071, GAV-90101, GAV-90111, GAV-90121, GAV-90131, GAV-90141, GAV-90151, GAV-90161, GAV-90171

- Wireless control available through Bluetooth connection
- Daylight and occupancy sensor options

Optic



0

Product colour



01 - Black (RAL 9011) 03 - White (RAL 9003) 05 - Matt Silver (RAL 9006)

Special finishes upon request

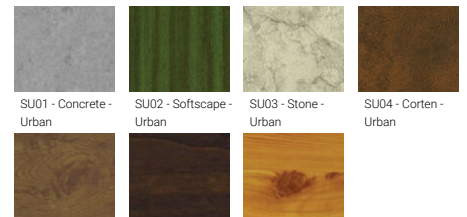

SU01 - Concrete - Urban SU02 - Softscape - Urban SU03 - Stone - Urban SU04 - Corten - Urban
SW01 - Oak - Woodland SW02 - Walnut - Woodland SW03 - Pine - Woodland

GAVLE 5 (GAV-90162)

Technical information

Material	Aluminium	Driver	Constant current (CC)	Product colours	Black, White, Matt Silver, Concrete - Urban, Softscape - Urban, Stone - Urban, Corten - Urban, Oak - Woodland, Walnut - Woodland, Pine - Woodland
Light source	3072 & 3072 LED	Input voltage	220-240 V 50/60 Hz	Weight	41.5 kg
Power	413 W	Optic	0	Operating temperature	-20 °C to 40 °C
Lumen	43232 lm	Optic value	102°	Variants (DALI)	Compatible with EN/ IEC 60598-2-22: Suitable for emergency installations as central supply, non-maintained (Z0)
Efficacy	105 lm/W	CCT / CRI	TW (2700K - 6500K)		
Driver option	Integral control gear	Dimming type	DALI		

GAV-90162

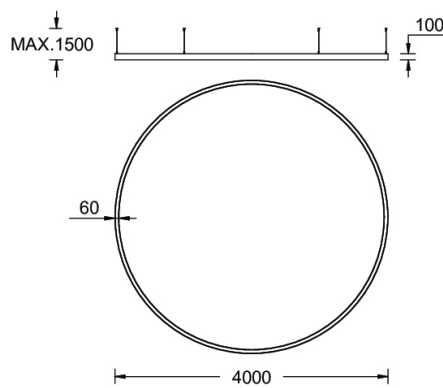

Accessories

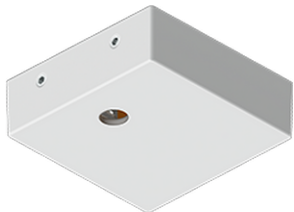

Supply cable surface mounting box
A80981



Xpress wireless switch
A90591

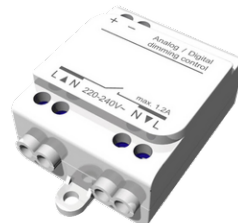

Wireless bluetooth converter
A90291



DALI Control System
Control-DALI