

LADOR 52 (LD-30061)



Product description

Integral control gear - 120x120 mm - Class I - RGBW



microPrim™

Luminaire Structure

- Die-cast aluminium housing
- Pre-treated before powder coating ensuring high corrosion resistance
- Thermal heat dissipation body
- Single cable entry, through wiring upon request
- Two cable gland supplied with 0.2 m of 3x1.0 sqmm outdoor cable and 0.2 m of 2x0.5 sqmm outdoor shielded cable
- Stainless steel fasteners in grade 304 with zinc flake coating (ZFC)
- Durable silicone rubber gasket
- Clear toughened glass
- High-efficiency PMMA lens
- Integral control gear
- Optional surface mounting box for easy wiring or conduit connection when wiring from behind is not possible

Optic

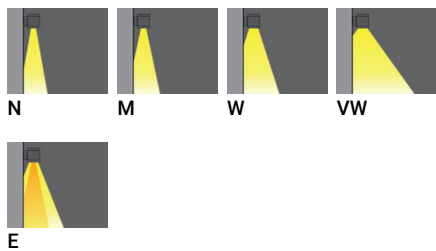

Product colour

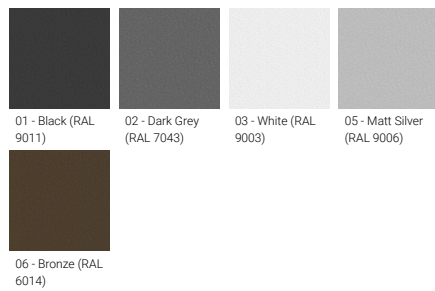

Special finishes upon request

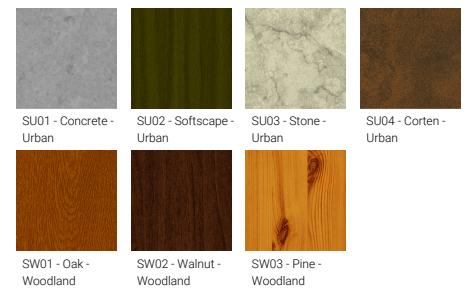

LADOR 52 (LD-30061)

Technical information

Material	Aluminium
Light source	8 LED
Power	22 W
Lumen	853 - 1133 lm
Efficacy	39 - 52 lm/W
Driver option	Integral control gear
Driver	Constant current (CC)
Input voltage	220-240 V 50/60 Hz

Optic	N, M, W, VW, E
Optic value	8°, 17°, 26°, 65°, 43°x11°
CCT / CRI	RGBW30, RGBW40
Bug	B1-U0-G0
ULR	<1%
ULOR	<1%
CIE flux code n°3	100
Dimming type	DMX, DMX/RDM

Product colours	Black, Dark Grey, White, Matt Silver, Bronze, Concrete - Urban, Softscape - Urban, Stone - Urban, Corten - Urban, Oak - Woodland, Walnut - Woodland, Pine - Woodland
Weight	2.1 kg
Operating temperature	-20 °C to 40 °C
Cable	Two cable gland supplied with 0.2 m of 3x1.0 sqmm outdoor cable and 0.2 m of 2x0.5 sqmm outdoor shielded cable
Through wiring	Single cable entry, through wiring upon request
Lens / Reflector / Optic	Clear toughened glass, High-efficiency PMMA lens
Variants (DMX/RDM)	Compatible with EN/ IEC 60598-2-22: Suitable for emergency installations as central supply, non-maintained (Z0)

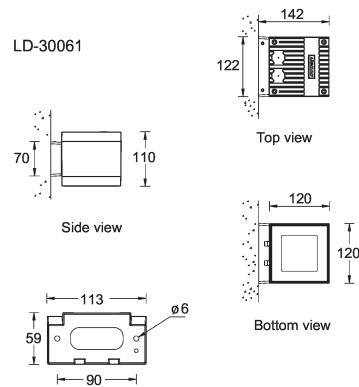

LADOR 52 (LD-30061)

Accessory



DMX Control System
Control-DMX



DMX/RDM Control System
Control-DMX-RDM