

LADOR 2 (LD-50012) (Version 1)

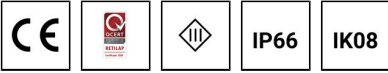

Product description

With remote driver IP-rated - Constant voltage (CV) 24 V - 82x82 mm - Class III - RGBW



Luminaire Structure

- Die-cast aluminium housing
- Thermal heat dissipation body
- Pre-treated before powder coating ensuring high corrosion resistance
- Single cable entry
- One IP68 connector supplied with 0.2 m of 8x0.5 sqmm outdoor cable
- Stainless steel fasteners in grade 304 with zinc flake coating (ZFC)
- Durable silicone rubber gasket
- High-efficiency PMMA lens
- Clear toughened glass
- Remote driver (included)
- LADOR 1, 2, 3 and 4 are not available in European Union

Optic

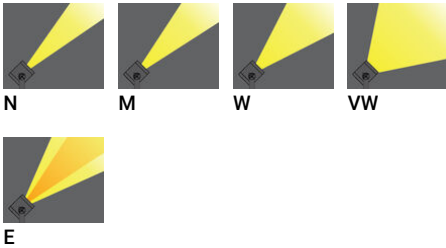

Product colour

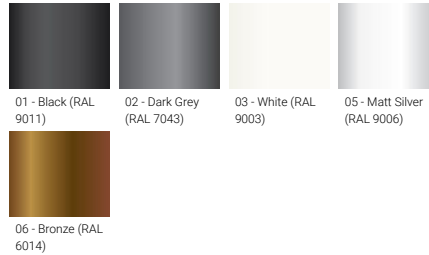

Special finishes upon request

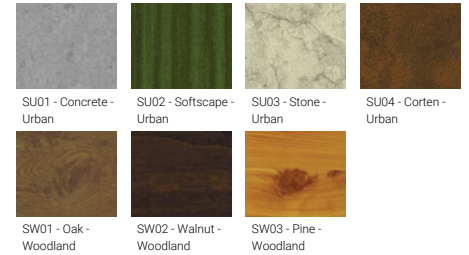

LADOR 2 (LD-50012) (Version 1)

Technical information

Material	Aluminium	Optic value	8°, 17°, 26°, 65°, 43°x11°	Operating temperature	-20 °C to 40 °C
Light source	4 LED	CCT / CRI	RGBW30, RGBW40	Cable	One IP68 connector supplied with 0.2 m of 8x0.5 sqmm outdoor cable
Power	10 W	Bug	B1-U0-G0	Through wiring	Single cable entry
Lumen	406 - 520 lm	ULR	0%	Lens / Reflector / Optic	High-efficiency PMMA lens, Clear toughened glass
Efficacy	41 - 52 lm/W	ULOR	0%	MacAdam Ellipse	7 SDCM
Driver option	Remote driver (included)	CIE flux code n°3	100	Lifetime L90B10 (hours)	> 50,000
Driver	Constant voltage (CV)	Dimming type	DMX, DMX/RDM	Lifetime L80B10 (hours)	> 68,000
Input voltage	24 VDC	Product colours	Black, Dark Grey, White, Matt Silver, Bronze, Concrete - Urban, Softscape - Urban, Stone - Urban, Corten - Urban, Oak - Woodland, Walnut - Woodland, Pine - Woodland	Lifetime L80B50 (hours)	> 100,000
Optic	N, M, W, VW, E			Variants (DMX/RDM)	Compatible with EN/ IEC 60598-2-22: Suitable for emergency installations as central supply, non-maintained (Z0)
		Weight	1 kg		

LD-50012

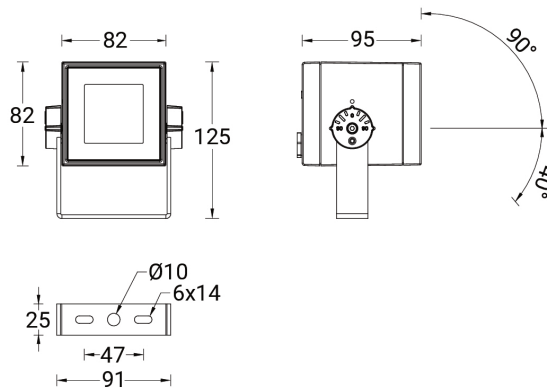

Accessories



DMX Control System
Control-DMX



DMX/RDM Control System
Control-DMX-RDM



Ground spike
A50941

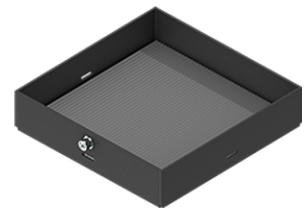

Linear spread lens
A51214

LADOR 2 (LD-50012) (Version 1)

Anti-glare visor
A52931

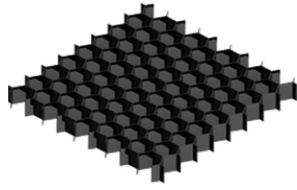

Honeycomb louvre
A51921

Please contact the factory for technical details if you wish to use Anti-glare accessories, Colour filters, Lenses and slip glasses in combination.