

LADOR 31 (LD-50191)

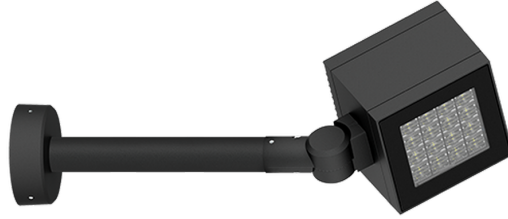

Product description

Bracket mounted - Integral control gear - 146x146 mm
- Class I



Luminaire Structure

- Die-cast aluminium housing
- Pre-treated before powder coating ensuring high corrosion resistance
- Thermal heat dissipation body
- Adjustable: Tilt 80° (Up) & 40° (Down), Rotation 350°

- Single cable entry
- Stainless steel fasteners in grade 304 with zinc flake coating (ZFC)
- Durable silicone rubber gasket
- High-efficiency PMMA lens

- Clear toughened glass
- Integral control gear

Optic

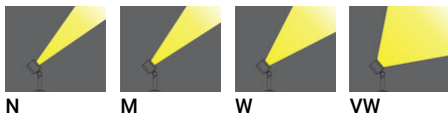

Product colour

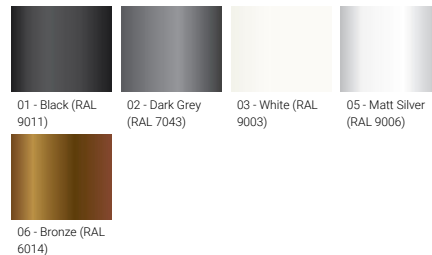

Special finishes upon request

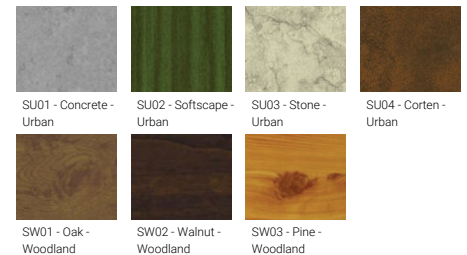

LADOR 31 (LD-50191)

Technical information



Material	Aluminium
Light source	16 LED
Power	35 W
Lumen	3263 - 4110 lm
Efficacy	93 - 117 lm/W
Driver option	Integral control gear
Driver	Constant current (CC)
Input voltage	220-240 V 50/60 Hz
Optic	N, M, W, VW, E

Optic value	10°, 16°, 33°, 72°, 43°x11°
CCT / CRI	3000K CRI80, 4000K CRI80
Bug	B2-U0-G0, B3-U0-G0
ULR	0%
ULOR	0%
CIE flux code n°3	100
Dimming type	On/Off, 1-10V, DALI
Product colours	Black, Dark Grey, White, Matt Silver, Bronze, Concrete - Urban, Softscape - Urban, Stone - Urban, Corten - Urban, Oak - Woodland, Walnut - Woodland, Pine - Woodland
Weight	4 kg

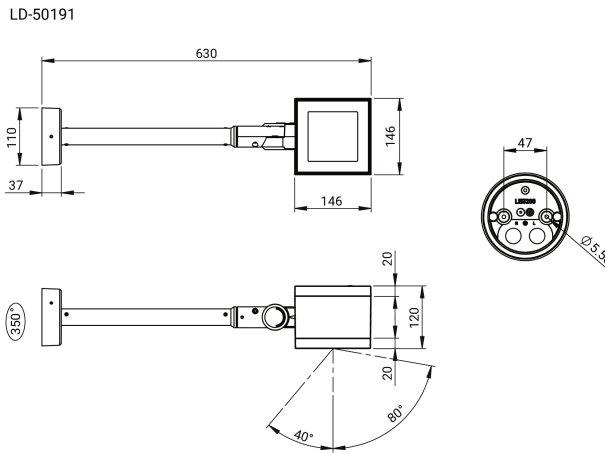
Operating temperature	-20 °C to 40 °C
Through wiring	Single cable entry
Lens / Reflector / Optic	High-efficiency PMMA lens, Clear toughened glass
MacAdam Ellipse	3 SDCM
Lifetime L90B10 (hours)	> 120,000
Lifetime L80B10 (hours)	> 120,000
Lifetime L80B50 (hours)	> 120,000
Variants (1-10V, DALI)	Compatible with EN/ IEC 60598-2-22: Suitable for emergency installations as central supply, non-maintained (Z0)

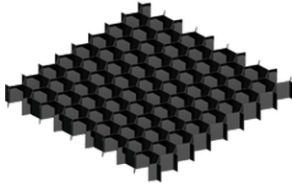
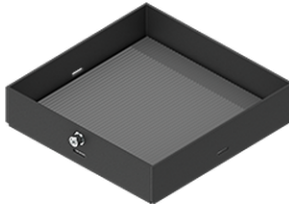

Accessories

			
Anti-glare visor A53131	Honeycomb louvre A52121	Linear spread lens A51414	Ground spike A51041

LADOR 31 (LD-50191)

DALI Control System
Control-DALI

Please contact the factory for technical details if you wish to use Anti-glare accessories, Colour filters, Lenses and slip glasses in combination.