

**LIGHTSOFT 19 (LH-10813)****Product description**

186x186 mm - 1000 mm - 10.5 hours of operation time (2 Step dimming with motion sensor override) - 5 days of autonomy

**Luminaire Structure**

- High-efficiency polycarbonate lens

- Anodised, high-purity aluminium reflector

**Optic**

W VW T2 T3

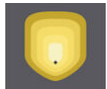

T4

**Product colour**

01 - Black (RAL 9011) 02 - Dark Grey (RAL 7043) 03 - White (RAL 9003) 05 - Matt Silver (RAL 9006)

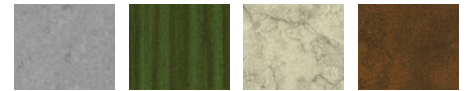

06 - Bronze (RAL 6014)

**Special finishes upon request**

SU01 - Concrete - Urban SU02 - Softscape - Urban SU03 - Stone - Urban SU04 - Corten - Urban



SW01 - Oak - Woodland SW02 - Walnut - Woodland SW03 - Pine - Woodland

**LIGHTSOFT 19 (LH-10813)**

**Technical information**

<b>Material</b>	Aluminium	<b>Optic value</b>	108°, 120°, 136°x22°, 140°x44°, 148°x78°	<b>Lens / Reflector / Optic</b>	High-efficiency polycarbonate lens, Anodised, high-purity aluminium reflector
<b>Light source</b>	24 LED	<b>CCT / CRI</b>	3000K CRI80, 4000K CRI80	<b>MacAdam Ellipse</b>	3 SDCM
<b>Power</b>	6 W	<b>Dimming type</b>	Dusk to Dawn, 2 Step dimming with motion sensor override, Solar Custom	<b>Lifetime L90B10 (hours)</b>	> 120,000
<b>Lumen</b>	528 lm	<b>Product colours</b>	Black, Dark Grey, White, Matt Silver, Bronze, Concrete - Urban, Softscape - Urban, Stone - Urban, Corten - Urban, Oak - Woodland, Walnut - Woodland, Pine - Woodland	<b>Lifetime L80B10 (hours)</b>	> 120,000
<b>Efficacy</b>	88 lm/W	<b>Weight</b>	19 kg	<b>Lifetime L80B50 (hours)</b>	> 120,000
<b>Optic</b>	W, VW, T2, T3, T4	<b>Operating temperature</b>	-20 °C to 40 °C		

**LIGHTSOFT**  
Adjustable sensor ( 10 - 150 seconds )  
360° sensitivity  
Sensor detection area: 7 - 10 m

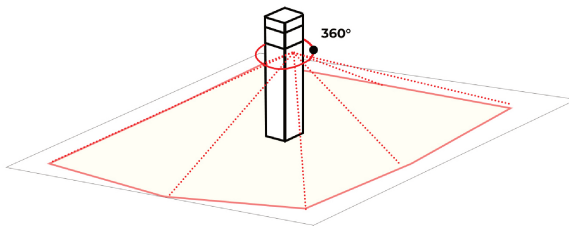

LH-10813

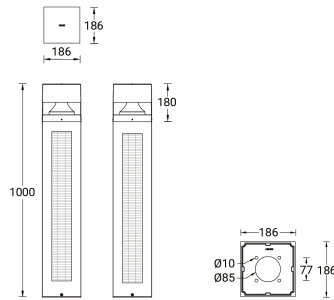

**Accessories**



Anchor bolt  
**A10391**



Remote solar charge controller  
for Solar Integrated Post Top  
luminaire  
**A92291**