

LIGHTSOFT 20 (LH-10823)



Product description

186x186 mm - 1000 mm - 10.5 hours of operation time (2 Step dimming with motion sensor override) - 5 days of autonomy



Luminaire Structure

- Die-cast aluminium housing
- Extruded aluminium column
- Pre-treated before powder coating ensuring high corrosion resistance
- Stainless steel fasteners in grade 304 with zinc flake coating (ZFC)
- Durable silicone rubber gasket
- Clear UV-stabilised polycarbonate diffuser
- Anodised, high-purity aluminium reflector
- Integral control gear

- Solar panel mono-crystalline silicon high-efficiency 4x10W
- Lithium Iron Phosphate (LiFePO4) battery 16.5Ah 12 VDC
- Solar charger controller system 12V 10A
- Luminaires operation time depends on the weather conditions
- Full automatic electronic protection function against short circuit, overcurrent, overload, overvoltage and high temperature
- Standard: Off-grid, 100% solar, not connected to the utility grid. Utility grid connection is available upon request
- Without any sun (Autonomy), the battery would last for a maximum 5 days
- Motion sensor integrated

- Different dimming options are available
- STD: 2 Step dimming with motion sensor override (3 hours: 60% without movement, 100% for 1 minute when the motion sensor activated. After 3 hours: 30% without movement, 60% for 1 minute when the motion sensor activated)
- ND: Dusk to Dawn, CT: Custom examples are 5 Step dimming, Custom hours, Custom dimming levels (Step length and minimum dim level is 10%)
- Maximum 35.5 hours of operation time (2 Step dimming with motion sensor override)
- Remote solar charge controller can be ordered as an accessory
- Autonomy and Operation time calculations are done with the following information: Peak Sun-Hour (PSH) is 3 hours. Hours of operation are 12 hours per day. Detection of movement is 5 times per hour.
- Autonomy and Operation time calculations are only indicative and will depend on several variable factors. Please contact the factory to determine the specific calculations for your project.

Optic



W VW T2 T3



T4

Product colour



01 - Black (RAL 9011) 02 - Dark Grey (RAL 7043) 03 - White (RAL 9003) 05 - Matt Silver (RAL 9006)



06 - Bronze (RAL 6014)

Special finishes upon request

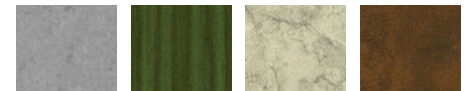

SU01 - Concrete - Urban SU02 - Softscape - Urban SU03 - Stone - Urban SU04 - Corten - Urban



SW01 - Oak - Woodland SW02 - Walnut - Woodland SW03 - Pine - Woodland

LIGHTSOFT 20 (LH-10823)

Technical information

Material	Aluminium
Light source	18 LED
Power	6 W
Lumen	528 lm
Efficacy	88 lm/W
Driver option	Integral control gear
Driver	Constant current (CC)

Input voltage	Solar
Optic	W, VW, T2, T3, T4
Optic value	108°, 120°, 136°x22°, 140°x44°, 148°x78°
CCT / CRI	3000K CRI80, 4000K CRI80
Dimming type	Dusk to Dawn, 2 Step dimming with motion sensor override, Solar Custom
Product colours	Black, Dark Grey, White, Matt Silver, Bronze, Concrete - Urban, Softscape - Urban, Stone - Urban, Corten - Urban, Oak - Woodland, Walnut - Woodland, Pine - Woodland
Weight	19 kg

Operating temperature	-20 °C to 40 °C
Lens / Reflector / Optic	Clear UV-stabilised polycarbonate diffuser, Anodised, high-purity aluminium reflector
MacAdam Ellipse	3 SDCM
Lifetime L90B10 (hours)	> 120,000
Lifetime L80B10 (hours)	> 120,000
Lifetime L80B50 (hours)	> 120,000

LIGHTSOFT
Adjustable sensor (10 - 150 seconds)
360° sensitivity
Sensor detection area: 7 - 10 m

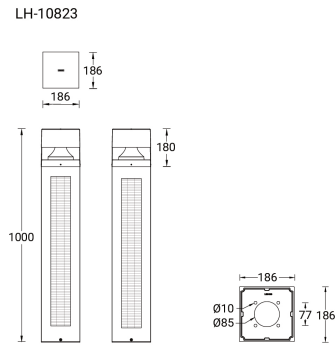
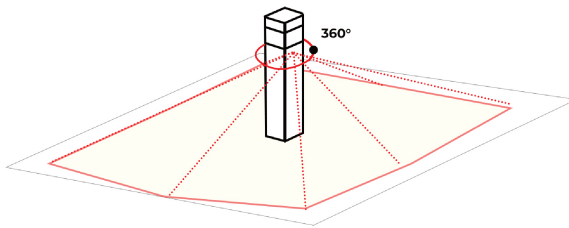

Accessories



Anchor bolt
A10391



Remote solar charge controller
for Solar Integrated Bollards and
Vertical Solar PV poles
A92691