

MALMO 4 (MAL-90041)



Product description

Down - 980 mm



Luminaire Structure

- Extruded aluminium bended profile with powder coating
- Stainless steel fasteners in grade 316
- Stainless steel, adjustable, suspension (1.5 m) complete with electrical wires in white for mounting
- PMMA diffuser with Opal (UGR <19) and micro prismatic (UGR <13) options for better glare control

- Up and down light distribution options
- Passive thermal management
- Integral control gear
- Wireless control available through Bluetooth connection

- Daylight and occupancy sensor options
- Emergency module (1 or 3 hours) is available upon request with 3 options (BASIC, SELF-TEST, PRO-DALI)

Optic



P

Product colour



01 - Black (RAL 9011) 03 - White (RAL 9003) 05 - Matt Silver (RAL 9006)

Special finishes upon request

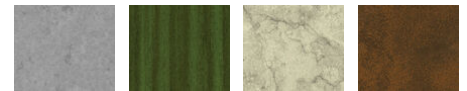

SU01 - Concrete - Urban SU02 - Softscape - Urban SU03 - Stone - Urban SU04 - Corten - Urban



SW01 - Oak - Woodland SW02 - Walnut - Woodland SW03 - Pine - Woodland

MALMO 4 (MAL-90041)

Technical information

Material	Aluminium	Input voltage	220-240 V 50/60 Hz	CIE flux code n°3	96, 97
Light source	1872 LED	Optic	O, P	Dimming type	On/Off, 1-10V, DALI
Power	111 W	Optic value	107°, 94°	Product colours	Black, White, Matt Silver, Concrete - Urban, Softscape - Urban, Stone - Urban, Corten - Urban, Oak - Woodland, Walnut - Woodland, Pine - Woodland
Lumen	13262 - 15647 lm	CCT / CRI	3000K CRI80, 4000K CRI80		
Efficacy	71 - 84 lm/W	Bug	B3-U0-G1, B3-U0-G2		
Driver option	Integral control gear	ULR	0%	Weight	12.8 kg
Driver	Constant current (CC)	ULOR	0%	Operating temperature	-20 °C to 40 °C
				Variants (On/Off, 1-10V, DALI)	Compatible with EN/ IEC 60598-2-22: Suitable for emergency installations as central supply, non-maintained (Z0)

MAL-90041

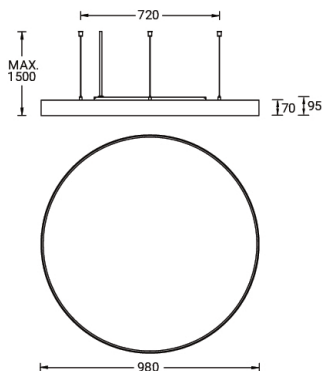

Accessories

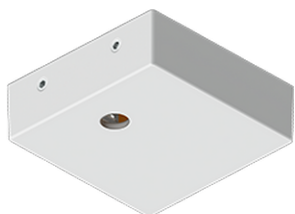

Supply cable surface mounting box
A80981

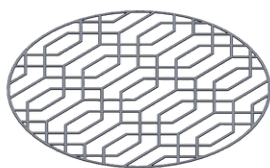

Decorative pattern - Type A for MALMO 1000 mm
A91221

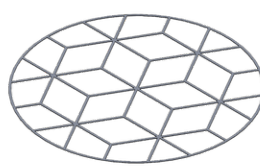

Decorative pattern - Type B for MALMO 1000 mm
A92621

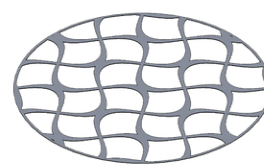

Decorative pattern - Type C for MALMO 1000 mm
A94021

MALMO 4 (MAL-90041)

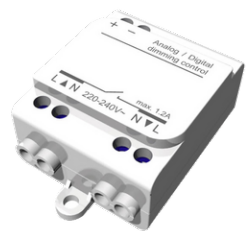

Wireless bluetooth converter
A90291



Xpress wireless switch
A90591

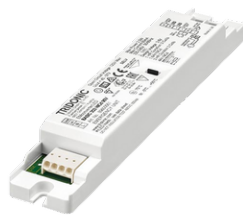

Emergency module - 250V -
BASIC
EM250V-BA



Emergency module - 250V -
PRO-DALI
EM250V-DA



Emergency module - 250V -
SELF-TEST
EM250V-ST



DALI Control System
Control-DALI