

**MALMO 4 (MAL-90142)**



**Product description**

Down (Optic) & Up (Optic 2nd) - 980 mm



microPrim™

**Luminaire structure**

- Extruded aluminium bended profile with powder coating
- Passive thermal management
- Stainless steel fasteners in grade 304 with zinc flake coating (ZFC)
- PMMA diffuser with Opal (UGR <19) and micro prismatic (UGR <13) options for better glare control

- Integral control gear
- Stainless steel, adjustable, suspension (1.5 m) complete with electrical wires in white for mounting
- Up and down light distribution options
- Wireless control available through Bluetooth connection

- Daylight and occupancy sensor options
- Emergency module (1 or 3 hours) is available upon request with 3 options (BASIC, SELF-TEST, PRO-DALI)

**Product colour**



01 - Black (RAL 9011)    03 - White (RAL 9003)    05 - Matt Silver (RAL 9006)

**Special finishes upon request**



SU01 - Concrete - Urban    SU02 - Softscape - Urban    SU03 - Stone - Urban    SU04 - Corten - Urban



SW01 - Oak - Woodland    SW02 - Walnut - Woodland    SW03 - Pine - Woodland

**MALMO 4 (MAL-90142)**

**Technical information**

<b>Material</b>	Aluminium
<b>Light source</b>	1872 & 588 LED
<b>Power</b>	308 W
<b>Lumen</b>	31605 - 35579 lm
<b>Efficacy</b>	103 - 116 lm/W
<b>Driver option</b>	Integral control gear
<b>Driver</b>	Constant current (CC)
<b>Input voltage</b>	220-240 V 50/60 Hz

<b>Optic</b>	O, P
<b>Optic value</b>	107°, 94°
<b>Optic (2nd)</b>	O
<b>Optic (2nd) value</b>	110°
<b>CCT / CRI</b>	3000K CRI80, 4000K CRI80
<b>Bug</b>	B4-U5-G2
<b>ULR</b>	38%, 41%
<b>ULOR</b>	38%, 41%

<b>CIE flux code n°3</b>	96, 97
<b>Dimming type</b>	On/Off, 1-10V, DALI
<b>Product colours</b>	Black, White, Matt Silver, Concrete - Urban, Softscape - Urban, Stone - Urban, Corten - Urban, Oak - Woodland, Walnut - Woodland, Pine - Woodland
<b>Weight</b>	13.9 kg
<b>Operating temperature</b>	-20 °C to 40 °C
<b>Variants (On/Off, 1-10V, DALI)</b>	Compatible with EN/ IEC 60598-2-22: Suitable for emergency installations as central supply, non-maintained (Z0)

MAL-90142

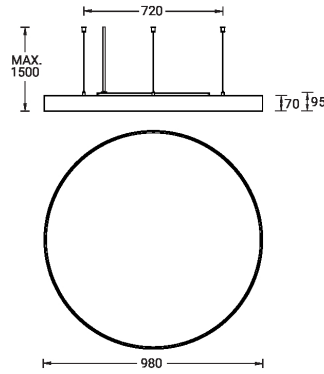

**MALMO 4 (MAL-90142)****Accessory**

Supply cable surface mounting  
box  
**A80981**



Wireless bluetooth converter  
**A90291**



Xpress wireless switch  
**A90591**

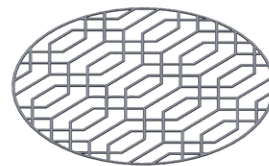

Decorative pattern - Type A for  
MALMO 1000 mm  
**A91221**

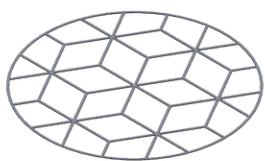

Decorative pattern - Type B for  
MALMO 1000 mm  
**A92621**

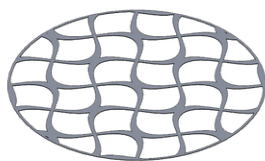

Decorative pattern - Type C for  
MALMO 1000 mm  
**A94021**



DALI Control System  
**Control-DALI**