

MALMO 4 (MAL-90154)



Product description

Down (Optic) & Up (Optic 2nd) - 1180 mm - RGBW



Luminaire Structure

- Extruded aluminium bended profile with powder coating
- Stainless steel fasteners in grade 316
- Stainless steel, adjustable, suspension (1.5 m) complete with electrical wires in white for mounting
- PMMA diffuser with Opal (UGR <19) and micro prismatic (UGR <13) options for better glare control

- Up and down light distribution options
- Passive thermal management
- Integral control gear
- Wireless control available through Bluetooth connection

- Daylight and occupancy sensor options
- Emergency module (1 or 3 hours) is available upon request with 3 options (BASIC, SELF-TEST, PRO-DALI)

Product colour

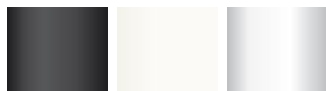

01 - Black (RAL 9011) 03 - White (RAL 9003) 05 - Matt Silver (RAL 9006)

Special finishes upon request

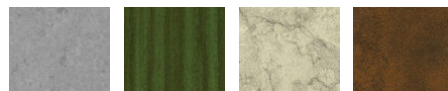

SU01 - Concrete - Urban SU02 - Softscape - Urban SU03 - Stone - Urban SU04 - Corten - Urban



SW01 - Oak - Woodland SW02 - Walnut - Woodland SW03 - Pine - Woodland

MALMO 4 (MAL-90154)

Technical information

Material	Aluminium	Input voltage	220-240 V 50/60 Hz	Dimming type	Bluetooth
Light source	5472 & 864 LED	Optic	0, P	Product colours	Black, White, Matt Silver, Concrete - Urban, Softscape - Urban, Stone - Urban, Corten - Urban, Oak - Woodland, Walnut - Woodland, Pine - Woodland
Power	396 W	Optic value	107°, 94°		
Lumen	13721 lm	Optic (2nd)	0	Weight	20.6 kg
Driver option	Integral control gear	Optic (2nd) value	110°	Operating temperature	-20 °C to 40 °C
Driver	Constant current (CC)	CCT / CRI	RGBW30, RGBW40	Variants (Bluetooth)	Compatible with EN/ IEC 60598-2-22: Suitable for emergency installations as central supply, non-maintained (Z0)

MAL-90154

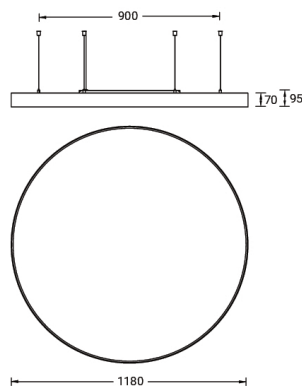

Accessories

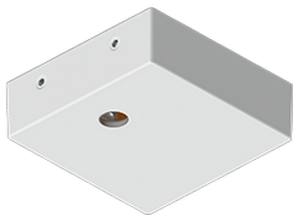

Supply cable surface mounting box
A80981



Xpress wireless switch
A90591

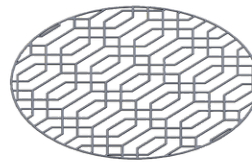

Decorative pattern - Type A for
MALMO 1200 mm
A91321

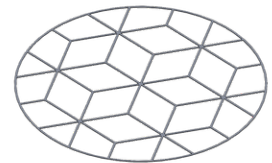

Decorative pattern - Type B for
MALMO 1200 mm
A92721

MALMO 4 (MAL-90154)

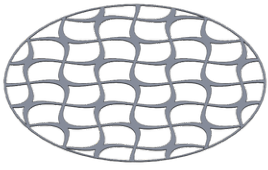

Decorative pattern - Type C for
MALMO 1200 mm
A94121



Recessing box
A61051



DALI Control System
Control-DALI