

NYBRO 18 (NYB-80902-SU)

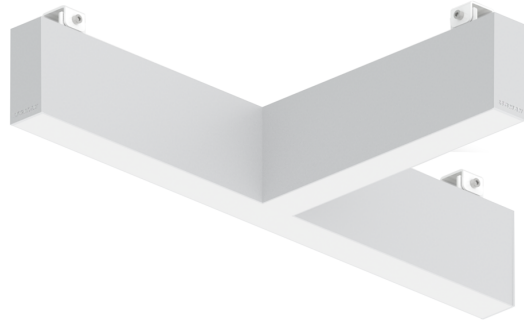

Product description

Down (Optic) & Up (Optic 2nd) - T90° - 40x95 mm - 335 mm



Luminaire Structure

- Die-cast aluminium end-caps and extruded aluminium profile with powder coating
- Stainless steel fasteners in grade 316
- Stainless steel brackets and screws for mounting

- PMMA diffuser with Opal (UGR <19) and micro prismatic (UGR <13) options for better glare control
- Up and down light distribution options
- Passive thermal management

- Integral control gear
- Wireless control available through Bluetooth connection
- Daylight and occupancy sensor options

Optic



P / O

Product colour



01 - Black (RAL 9011) 03 - White (RAL 9003) 05 - Matt Silver (RAL 9006)

Special finishes upon request

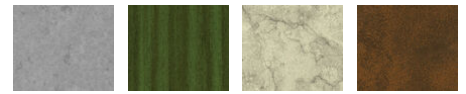

SU01 - Concrete - Urban SU02 - Softscape - Urban SU03 - Stone - Urban SU04 - Corten - Urban



SW01 - Oak - Woodland SW02 - Walnut - Woodland SW03 - Pine - Woodland

NYBRO 18 (NYB-80902-SU)

Technical information

Material	Aluminium	Optic	O, P	Operating temperature	-20 °C to 40 °C
Light source	108 & 96 LED	Optic value	Opal, Micro-prismatic	MacAdam Ellipse	3 SDCM
Power	35 W	Optic (2nd)	O	Lifetime L90B10 (hours)	> 23,000
Lumen	3069 - 3386 lm	Optic (2nd) value	Opal	Lifetime L80B10 (hours)	> 45,000
Efficacy	88 - 97 lm/W	CCT / CRI	3000K CRI80, 4000K CRI80	Lifetime L80B50 (hours)	> 50,000
Driver option	Integral control gear	Dimming type	On/Off, DALI	Variants (On/Off, DALI)	Compatible with EN/ IEC 60598-2-22: Suitable for emergency installations as central supply, non-maintained (Z0)
Driver	Constant current (CC)	Product colours	Black, White, Matt Silver, Concrete - Urban, Softscape - Urban, Stone - Urban, Corten - Urban, Oak - Woodland, Walnut - Woodland, Pine - Woodland		
Input voltage	220-240 V 50/60 Hz	Weight	3.47 kg.		

NYB-80902-SU

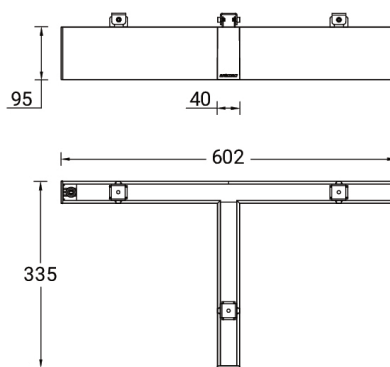

Accessories

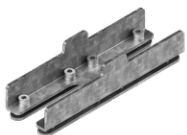

Continuous-coupler bracket
(40/50 mm Down profile)
A81881



DALI Control System
Control-DALI