

NYBRO 11 (NYB-81072-RE)



Product description

Down - L90° corner - 40x80 mm - 350 mm - Trimless



Luminaire Structure

- Die-cast aluminium end-caps and extruded aluminium profile with powder coating
- Cut the connection angle according to the shape
- Stainless steel fasteners in grade 316
- Stainless steel brackets and screws for mounting

- PMMA diffuser with Opal (UGR <19) and micro prismatic (UGR <13) options for better glare control
- Up and down light distribution options
- Passive thermal management
- Integral control gear

- Wireless control available through Bluetooth connection
- Daylight and occupancy sensor options

Optic

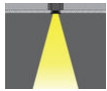

P

Product colour



01 - Black (RAL 9011) 03 - White (RAL 9003) 05 - Matt Silver (RAL 9006)

Special finishes upon request

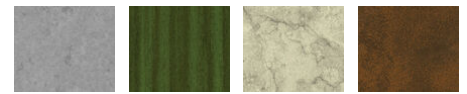

SU01 - Concrete - Urban SU02 - Softscape - Urban SU03 - Stone - Urban SU04 - Corten - Urban



SW01 - Oak - Woodland SW02 - Walnut - Woodland SW03 - Pine - Woodland

NYBRO 11 (NYB-81072-RE)

Technical information

Material	Aluminium	Input voltage	220-240 V 50/60 Hz	Operating temperature	-20 °C to 40 °C
Light source	72 LED	Optic	O, P	MacAdam Ellipse	3 SDCM
Power	14 W	Optic value	Opal, Micro-prismatic	Lifetime L90B10 (hours)	> 23,000
Lumen	987 - 1195 lm	CCT / CRI	3000K CRI80, 4000K CRI80	Lifetime L80B10 (hours)	> 45,000
Efficacy	71 - 85 lm/W	Dimming type	On/Off, DALI	Lifetime L80B50 (hours)	> 50,000
Driver option	Integral control gear	Product colours	Black, White, Matt Silver, Concrete - Urban, Softscape - Urban, Stone - Urban, Corten - Urban, Oak - Woodland, Walnut - Woodland, Pine - Woodland	Variants (On/Off, DALI)	Compatible with EN/ IEC 60598-2-22: Suitable for emergency installations as central supply, non-maintained (Z0)
Driver	Constant current (CC)				
		Weight	1.97 kg.		

NYB-81072-RE

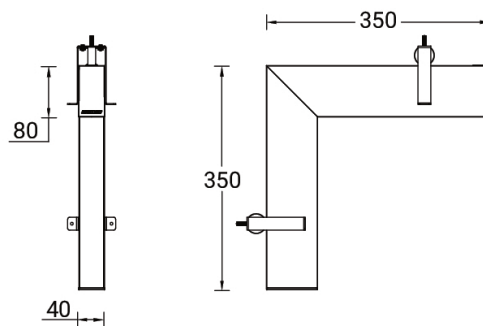

Accessories



Trimless-recessed mounting bracket (40 mm Down profile)
A82481



DALI Control System
Control-DALI