

OULU 3 (OUL-80244)

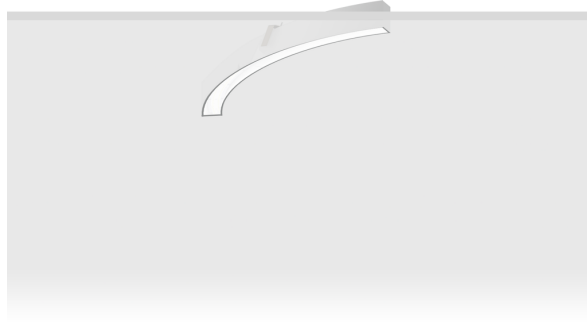

Product description

Down - 45° - R2500 - RGBW DMX



Luminaire Structure

- Extruded aluminium bended profile with powder coating
- Stainless steel fasteners in grade 316
- Stainless steel brackets and screws for mounting
- Opal PMMA diffuser (UGR <19) for glare control
- Up and down light distribution options
- Passive thermal management
- Integral control gear
- Remote driver is included for dimming type: 1-10V (-DI)
- Wireless control available through Bluetooth connection
- Daylight and occupancy sensor options

Optic

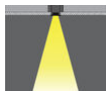

0

Product colour



01 - Black (RAL 9011) 03 - White (RAL 9003) 05 - Matt Silver (RAL 9006)

Special finishes upon request

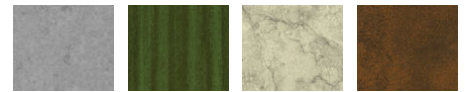

SU01 - Concrete - Urban SU02 - Softscape - Urban SU03 - Stone - Urban SU04 - Corten - Urban



SW01 - Oak - Woodland SW02 - Walnut - Woodland SW03 - Pine - Woodland

OULU 3 (OUL-80244)

Technical information

Material	Aluminium	Driver option	Integral control gear	Dimming type	DMX, DMX/RDM
Light source	688 LED	Driver	Constant current (CC)	Product colours	Black, White, Matt Silver, Concrete - Urban, Softscape - Urban, Stone - Urban, Corten - Urban, Oak - Woodland, Walnut - Woodland, Pine - Woodland
Power	37 W	Input voltage	220-240 V 50/60 Hz	Weight	5.0 kg
Lumen	1195 lm	Optic	0	Operating temperature	-20 °C to 40 °C
Efficacy	92 lm/W	CCT / CRI	RGBW40	Variants (DMX/RDM)	Compatible with EN/ IEC 60598-2-22: Suitable for emergency installations as central supply, non-maintained (Z0)

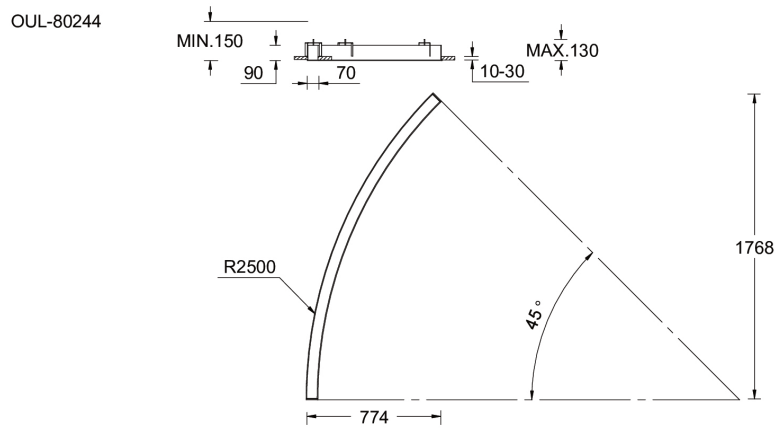

Accessories



Continuous-coupler bracket
A81781



DMX Control System
Control-DMX



DMX/RDM Control System
Control-DMX-RDM