

OULU 5 (OUL-80422)



Product description

Down - 180° - R750 - TW



Luminaire Structure

- Die-cast aluminium end-caps and extruded aluminium bended profile with powder coating
- Multiple angles available
- Stainless steel fasteners in grade 316
- Steel brackets for ceiling down mounting option

- Opal PMMA diffuser (UGR <19) for glare control
- Up and down light distribution options
- Passive thermal management
- Integral control gear

- Remote driver is included for dimming type: 1-10V (-DI)
- Wireless control available through Bluetooth connection

Optic



0

Product colour



01 - Black (RAL 9011) 03 - White (RAL 9003) 05 - Matt Silver (RAL 9006)

Special finishes upon request

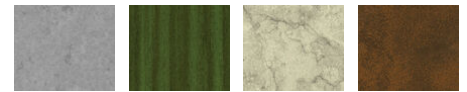

SU01 - Concrete - Urban SU02 - Softscape - Urban SU03 - Stone - Urban SU04 - Corten - Urban



SW01 - Oak - Woodland SW02 - Walnut - Woodland SW03 - Pine - Woodland

OULU 5 (OUL-80422)

Technical information

Material	Aluminium	Driver option	Remote driver (included)	Dimming type	DALI
Light source	576 LED	Driver	Constant current (CC)	Product colours	Black, White, Matt Silver, Concrete - Urban, Softscape - Urban, Stone - Urban, Corten - Urban, Oak - Woodland, Walnut - Woodland, Pine - Woodland
Power	40 W	Input voltage	250 mA,	Weight	5.7 kg
Lumen	4096 lm	Optic	0	Operating temperature	-20 °C to 40 °C
Efficacy	95 lm/W	CCT / CRI	TW (2700K - 6500K)	Variants (DALI)	Compatible with EN/ IEC 60598-2-22: Suitable for emergency installations as central supply, non-maintained (Z0)

OUL-80422

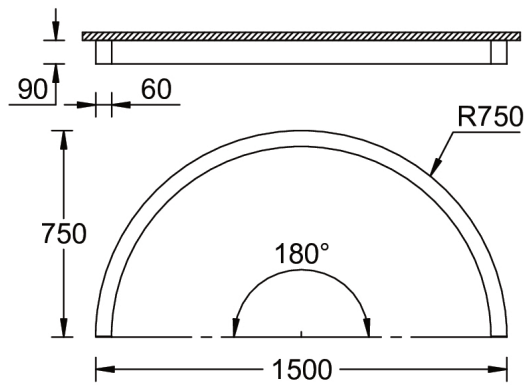

Accessories

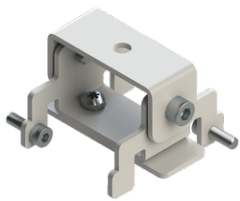

Ceiling-mounting bracket (40 mm profile)
A81381



Continuous-coupler bracket
A81781



Wireless bluetooth converter
A90291



Xpress wireless switch
A90591

OULU 5 (OUL-80422)



DALI Control System
Control-DALI
