

OULU 6 (OUL-80603)



Product description

Down - 90° - R500 - RGBW



Luminaire Structure

- Die-cast aluminium end-caps and extruded aluminium bended profile with powder coating
- Multiple angles available
- Stainless steel fasteners in grade 316
- Steel brackets for ceiling down mounting option

- Opal PMMA diffuser (UGR <19) for glare control
- Up and down light distribution options
- Passive thermal management
- Integral control gear

- Remote driver is included for dimming type: 1-10V (-DI)
- Wireless control available through Bluetooth connection

Optic



0

Product colour



01 - Black (RAL 9011) 03 - White (RAL 9003) 05 - Matt Silver (RAL 9006)

Special finishes upon request

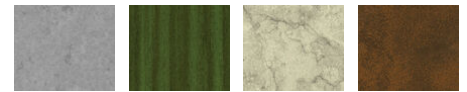

SU01 - Concrete - Urban SU02 - Softscape - Urban SU03 - Stone - Urban SU04 - Corten - Urban

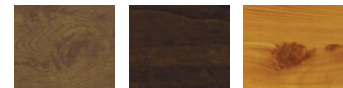

SW01 - Oak - Woodland SW02 - Walnut - Woodland SW03 - Pine - Woodland

OULU 6 (OUL-80603)

Technical information

Material	Aluminium	Driver	Constant current (CC)	Product colours	Black, White, Matt Silver, Concrete
Light source	240 LED	Input voltage	220-240 V 50/60 Hz		- Urban, Softscape - Urban, Stone
Power	13 W	Optic	0	- Urban, Corten - Urban, Oak -	Woodland, Walnut - Woodland,
Lumen	439 lm	Optic value	Opal	Pine - Woodland	
Efficacy	34 lm/W	CCT / CRI	RGBW40	Weight	2.0 kg
Driver option	Integral control gear	Dimming type	Bluetooth	Operating temperature	-20 °C to 40 °C
				Variants (Bluetooth)	Compatible with EN/ IEC 60598-2-22: Suitable for emergency installations as central supply, non-maintained (Z0)

OUL-80603

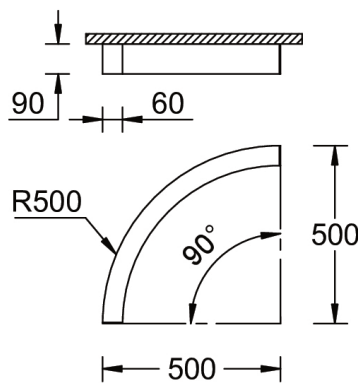

Accessories

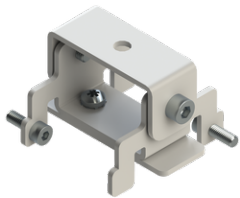

Ceiling-mounting bracket (40 mm profile)
A81381



Continuous-coupler bracket
A81781



Xpress wireless switch
A90591



Recessing box
A61051

OULU 6 (OUL-80603)



DALI Control System
Control-DALI
