

OULU 6 (OUL-80623)



Product description

Down - 90° - R1000 - RGBW



Luminaire Structure

- Die-cast aluminium end-caps and extruded aluminium bended profile with powder coating
- Multiple angles available
- Stainless steel fasteners in grade 316
- Steel brackets for ceiling down mounting option

- Opal PMMA diffuser (UGR <19) for glare control
- Up and down light distribution options
- Passive thermal management
- Integral control gear

- Remote driver is included for dimming type: 1-10V (-DI)
- Wireless control available through Bluetooth connection

Optic



0

Product colour



01 - Black (RAL 9011) 03 - White (RAL 9003) 05 - Matt Silver (RAL 9006)

Special finishes upon request

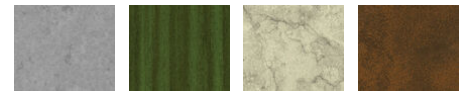

SU01 - Concrete - Urban SU02 - Softscape - Urban SU03 - Stone - Urban SU04 - Corten - Urban



SW01 - Oak - Woodland SW02 - Walnut - Woodland SW03 - Pine - Woodland

OULU 6 (OUL-80623)

Technical information

Material	Aluminium
Light source	480 LED
Power	26 W
Lumen	956 lm
Efficacy	37 lm/W
Driver option	Integral control gear

Driver	Constant current (CC)
Input voltage	220-240 V 50/60 Hz
Optic	0
Optic value	Opal
CCT / CRI	RGBW40
Dimming type	Bluetooth

Product colours	Black, White, Matt Silver, Concrete - Urban, Softscape - Urban, Stone - Urban, Corten - Urban, Oak - Woodland, Walnut - Woodland, Pine - Woodland
Weight	3.8 kg
Operating temperature	-20 °C to 40 °C
Variants (Bluetooth)	Compatible with EN/ IEC 60598-2-22: Suitable for emergency installations as central supply, non-maintained (Z0)

OUL-80623

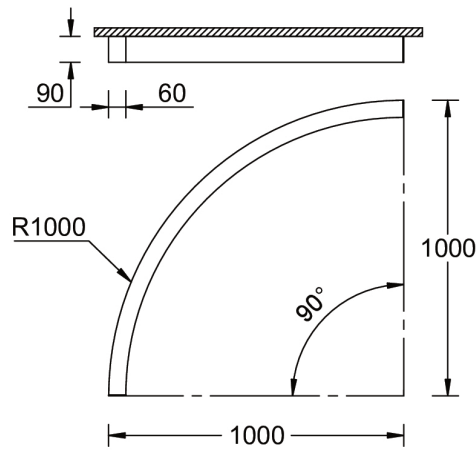

Accessories

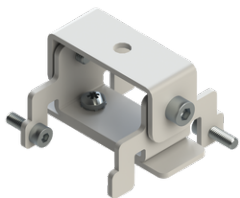

Ceiling-mounting bracket (40 mm profile)
A81381



Continuous-coupler bracket
A81781



Xpress wireless switch
A90591



Recessing box
A61051

OULU 6 (OUL-80623)



DALI Control System
Control-DALI
