

OULU 9 (OUL-90113)

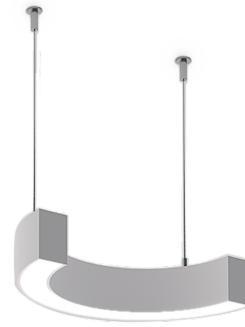

Product description

Down (Optic) & Up (Optic 2nd) - 180° - R500 - RGBW



Luminaire Structure

- Extruded aluminium bended profile with powder coating
- Stainless steel fasteners in grade 316
- Stainless steel, adjustable, suspension (1.5 m) complete with electrical wires in white for mounting
- Opal PMMA diffuser (UGR <19) for glare control

- Up and down light distribution options
- Passive thermal management
- Integral control gear
- Remote driver is included for dimming type: 1-10V (-DI)

- Wireless control available through Bluetooth connection
- Daylight and occupancy sensor options

Optic



0 / 0

Product colour



01 - Black (RAL 9011) 03 - White (RAL 9003) 05 - Matt Silver (RAL 9006)

Special finishes upon request



SU01 - Concrete - Urban SU02 - Softscape - Urban SU03 - Stone - Urban SU04 - Corten - Urban



SW01 - Oak - Woodland SW02 - Walnut - Woodland SW03 - Pine - Woodland

OULU 9 (OUL-90113)

Technical information

Material	Aluminium
Light source	480 LED
Power	54 W
Lumen	1912 lm
Efficacy	35 lm/W
Driver option	Remote driver (included)

Driver	Constant current (CC)
Input voltage	200 mA,
Optic	0
Optic value	Opal
Optic (2nd)	0
Optic (2nd) value	Opal

CCT / CRI	RGBW40
Dimming type	Bluetooth
Product colours	Black, White, Matt Silver, Concrete - Urban, Softscape - Urban, Stone - Urban, Corten - Urban, Oak - Woodland, Walnut - Woodland, Pine - Woodland
Weight	4.6 kg
Operating temperature	-20 °C to 40 °C
Variants (Bluetooth)	Compatible with EN/ IEC 60598-2-22: Suitable for emergency installations as central supply, non-maintained (Z0)

OUL-90113

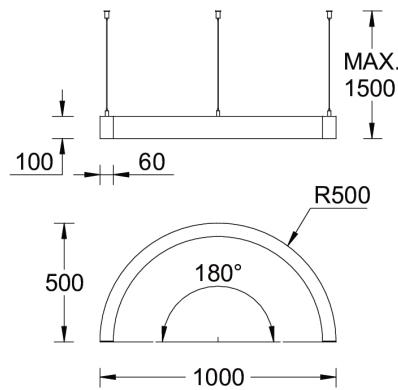

Accessories



Continuous-coupler bracket
A81781

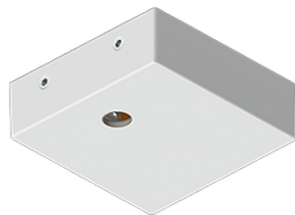

Supply cable surface mounting box
A80981



Xpress wireless switch
A90591



DALI Control System
Control-DALI