

OULU 10 (OUL-90314)



Product description

Down (Optic) & Up (Optic 2nd) - 90° - R750 - RGBW DMX



Luminaire Structure

- Extruded aluminium bended profile with powder coating
- Stainless steel fasteners in grade 316
- Stainless steel, adjustable, suspension (1.5 m) complete with electrical wires in white for mounting
- Opal PMMA diffuser (UGR <19) for glare control

- Up and down light distribution options
- Passive thermal management
- Integral control gear
- Remote driver is included for dimming type: 1-10V (-DI)

- Wireless control available through Bluetooth connection
- Daylight and occupancy sensor options

Optic



0

Product colour



01 - Black (RAL 9011) 03 - White (RAL 9003) 05 - Matt Silver (RAL 9006)

Special finishes upon request



SU01 - Concrete - Urban SU02 - Softscape - Urban SU03 - Stone - Urban SU04 - Corten - Urban



SW01 - Oak - Woodland SW02 - Walnut - Woodland SW03 - Pine - Woodland

OULU 10 (OUL-90314)

Technical information

Material	Aluminium
Light source	384 LED
Power	42 W
Lumen	1404 lm
Efficacy	27 lm/W
Driver option	Remote driver (included)

Driver	Constant current (CC)
Input voltage	200 mA,
Optic	0
Optic value	Opal
CCT / CRI	RGBW40
Dimming type	DMX, DMX/RDM

Product colours	Black, White, Matt Silver, Concrete - Urban, Softscape - Urban, Stone - Urban, Corten - Urban, Oak - Woodland, Walnut - Woodland, Pine - Woodland
Weight	3.5 kg
Operating temperature	-20 °C to 40 °C
Variants (DMX/RDM)	Compatible with EN/ IEC 60598-2-22: Suitable for emergency installations as central supply, non-maintained (Z0)

OUL-90314

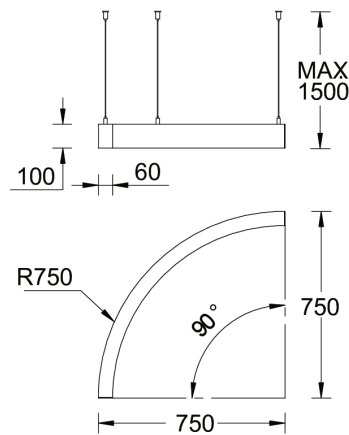

Accessories



Continuous-coupler bracket
A81781

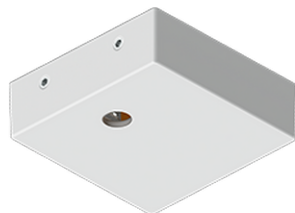

Supply cable surface mounting
box
A80981



DMX Control System
Control-DMX



DMX/RDM Control System
Control-DMX-RDM