

**OULU 11** (OUL-90413)



**Product description**

Down - 45° - R1250 - RGBW



**Luminaire Structure**

- Extruded aluminium bended profile with powder coating
- Stainless steel fasteners in grade 316
- Stainless steel, adjustable, suspension (1.5 m) complete with electrical wires in white for mounting
- Opal PMMA diffuser (UGR <19) for glare control

- Up and down light distribution options
- Passive thermal management
- Integral control gear
- Remote driver is included for dimming type: 1-10V (-DI)

- Wireless control available through Bluetooth connection
- Daylight and occupancy sensor options

**Optic**



0

**Product colour**



01 - Black (RAL 9011)    03 - White (RAL 9003)    05 - Matt Silver (RAL 9006)

**Special finishes upon request**



SU01 - Concrete - Urban    SU02 - Softscape - Urban    SU03 - Stone - Urban    SU04 - Corten - Urban



SW01 - Oak - Woodland    SW02 - Walnut - Woodland    SW03 - Pine - Woodland

**OULU 11 (OUL-90413)**

**Technical information**

<b>Material</b>	Aluminium
<b>Light source</b>	336 LED
<b>Power</b>	19 W
<b>Lumen</b>	559 lm
<b>Efficacy</b>	29 lm/W
<b>Driver option</b>	Remote driver (included)

<b>Driver</b>	Constant current (CC)
<b>Input voltage</b>	200 mA,
<b>Optic</b>	0
<b>Optic value</b>	Opal
<b>CCT / CRI</b>	RGBW40
<b>Dimming type</b>	Bluetooth

<b>Product colours</b>	Black, White, Matt Silver, Concrete - Urban, Softscape - Urban, Stone - Urban, Corten - Urban, Oak - Woodland, Walnut - Woodland, Pine - Woodland
<b>Weight</b>	2.7 kg
<b>Operating temperature</b>	-20 °C to 40 °C
<b>Variants (Bluetooth)</b>	Compatible with EN/ IEC 60598-2-22: Suitable for emergency installations as central supply, non-maintained (Z0)

OUL-90413

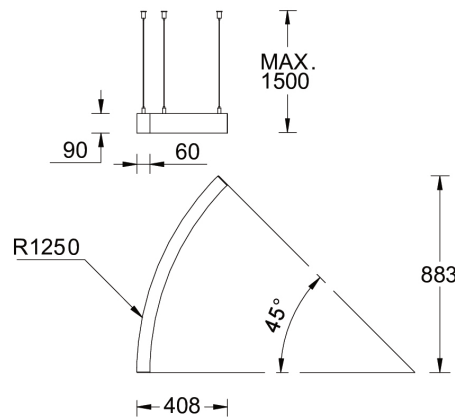

**Accessories**



Continuous-coupler bracket  
**A81781**

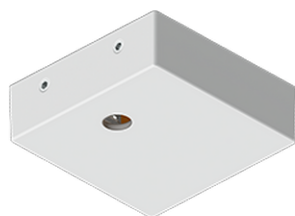

Supply cable surface mounting  
box  
**A80981**



Xpress wireless switch  
**A90591**



DALI Control System  
**Control-DALI**