

OULU 11 (OUL-90443)



Product description

Down - 45° - R2500 - RGBW



Luminaire Structure

- Extruded aluminium bended profile with powder coating
- Stainless steel fasteners in grade 316
- Stainless steel, adjustable, suspension (1.5 m) complete with electrical wires in white for mounting
- Opal PMMA diffuser (UGR <19) for glare control

- Up and down light distribution options
- Passive thermal management
- Integral control gear
- Remote driver is included for dimming type: 1-10V (-DI)

- Wireless control available through Bluetooth connection
- Daylight and occupancy sensor options

Optic



0

Product colour



01 - Black (RAL 9011) 03 - White (RAL 9003) 05 - Matt Silver (RAL 9006)

Special finishes upon request



SU01 - Concrete - Urban SU02 - Softscape - Urban SU03 - Stone - Urban SU04 - Corten - Urban



SW01 - Oak - Woodland SW02 - Walnut - Woodland SW03 - Pine - Woodland

OULU 11 (OUL-90443)

Technical information

Material	Aluminium	Driver	Constant current (CC)	Product colours	Black, White, Matt Silver, Concrete
Light source	688 LED	Input voltage	200 mA,		- Urban, Softscape - Urban, Stone
Power	37 W	Optic	0	- Urban, Corten - Urban, Oak -	Woodland, Walnut - Woodland,
Lumen	1195 lm	Optic value	Opal	Pine - Woodland	
Efficacy	32 lm/W	CCT / CRI	RGBW40	Weight	5.0 kg
Driver option	Remote driver (included)	Dimming type	Bluetooth	Operating temperature	-20 °C to 40 °C
				Variants (Bluetooth)	Compatible with EN/ IEC 60598-2-22: Suitable for emergency installations as central supply, non-maintained (Z0)

OUL-90443

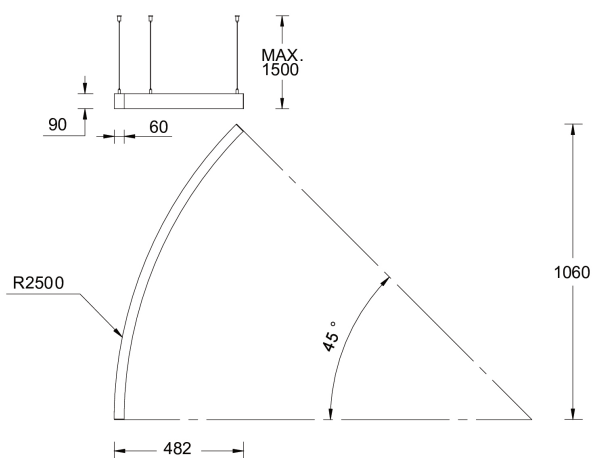

Accessories



Continuous-coupler bracket
A81781

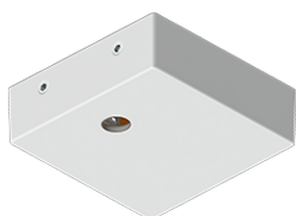

Supply cable surface mounting
box
A80981



Xpress wireless switch
A90591



DALI Control System
Control-DALI