

**POWERVISION 3 (PW39-GP164)**



**Luminaire Structure**

- Extruded aluminium housing
- Pre-treated before powder coating ensuring high corrosion resistance
- Thermal heat dissipation body
- Single cable entry, through wiring upon request
- One IP68 connector supplied with 0.2 m of 3x1.0 sqmm outdoor cable
- Stainless steel fasteners in grade 304 with zinc flake coating (ZFC)
- Durable silicone rubber gasket
- Clear toughened glass
- Integral control gear

**Optic**

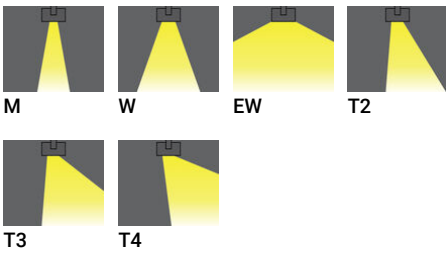

**Product colour**

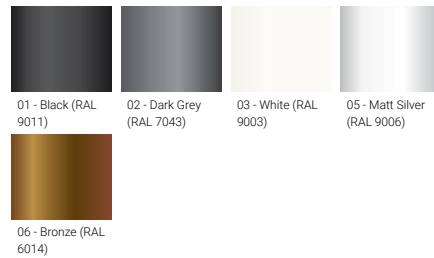

**Special finishes upon request**

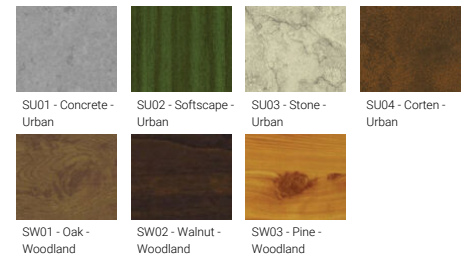

**POWERVISION 3 (PW39-GP164)**

**Technical information**

<b>Material</b>	Aluminium	<b>Optic</b>	M, W, EW, T2, T3, T4	<b>Through wiring</b>	Single cable entry, through wiring upon request
<b>Light source</b>	72 LED	<b>Optic value</b>	30°, 53°, 124°, 143°x54°, 143°x54°, 99°x78°	<b>Lens / Reflector / Optic</b>	Clear toughened glass
<b>Power</b>	159 W	<b>CCT / CRI</b>	3000K CRI80, 4000K CRI80	<b>MacAdam Ellipse</b>	3 SDCM
<b>Lumen</b>	17342 - 19965 lm	<b>Dimming type</b>	On/Off, 1-10V, DALI	<b>Lifetime L90B10 (hours)</b>	> 90,000
<b>Efficacy</b>	109 - 126 lm/W		Black, Dark Grey, White, Matt Silver, Bronze, Concrete - Urban, Softscape - Urban, Stone - Urban, Corten - Urban, Oak - Woodland, Walnut - Woodland, Pine - Woodland	<b>Lifetime L80B10 (hours)</b>	> 90,000
<b>Driver option</b>	Integral control gear	<b>Product colours</b>		<b>Lifetime L80B50 (hours)</b>	> 90,000
<b>Driver</b>	Constant current (CC)	<b>Weight</b>	14.5 kg	<b>Variants (On/Off, 1-10V, DALI)</b>	Compatible with EN/ IEC 60598-2-22: Suitable for emergency installations as central supply, non-maintained (Z0)
<b>Input voltage</b>	220-240 V 50/60 Hz	<b>Operating temperature</b>	-20 °C to 40 °C		
		<b>Cable</b>	One IP68 connector supplied with 0.2 m of 3x1.0 sqmm outdoor cable		

PW39-GP164

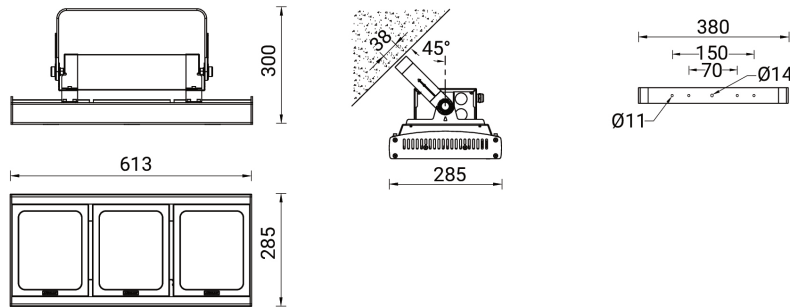

**Accessories**



DALI Control System  
Control-DALI