

VANCOUVER 52 (VA-20241)



Product description

240x240 mm - 3700 mm - Decorative pattern type 1 - IP65



microPrim™

Luminaire Structure

- Die-cast aluminium housing
- Extruded aluminium column
- Pre-treated before powder coating ensuring high corrosion resistance
- Single cable entry
- One IP68 connector supplied with 0.3 m of 3x1.0 sqmm outdoor cable
- Stainless steel fasteners in grade 304 with zinc flake coating (ZFC)
- Durable silicone rubber gasket
- High-efficiency optical reflector
- Clear toughened glass
- Integral control gear
- Maximum wind load resistance is 160 km/h
- Surge protection 10kV
- VANCOUVER luminaires with projectors on top and colder than 3000K CCT do not meet the IDA certification requirements

Optic



G

Product colour

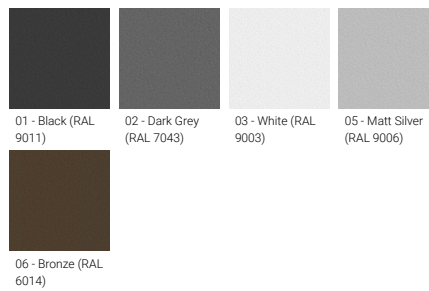

Special finishes upon request

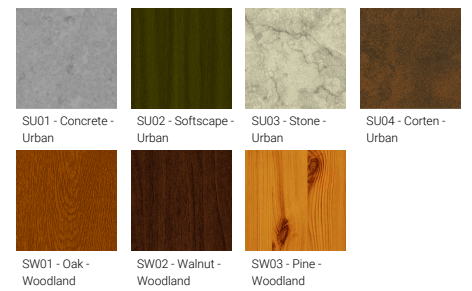

VANCOUVER 52 (VA-20241)

Technical information

Material	Aluminium
Light source	1 COB
Power	40 W
Lumen	2586 - 2781 lm
Efficacy	65 - 70 lm/W
Driver option	Integral control gear
Driver	Constant current (CC)
Input voltage	220-240 V 50/60 Hz

Optic	G
Optic value	134°
CCT / CRI	3000K CRI80, 4000K CRI80
Dimming type	On/Off, 1-10V, DALI
Product colours	Black, Dark Grey, White, Matt Silver, Bronze, Concrete - Urban, Softscape - Urban, Stone - Urban, Corten - Urban, Oak - Woodland, Walnut - Woodland, Pine - Woodland
Weight	55.0 kg
Operating temperature	-20 °C to 40 °C
EPA (m2)	0.888

Cable	One IP68 connector supplied with 0.3 m of 3x1.0 sqmm outdoor cable
Through wiring	Single cable entry
Lens / Reflector / Optic	High-efficiency optical reflector, Clear toughened glass
MacAdam Ellipse	3 SDCM
Lifetime L90B10 (hours)	> 50,700
Lifetime L80B10 (hours)	> 63,500
Lifetime L80B50 (hours)	> 63,500
Variants (1-10V, DALI)	Compatible with EN/ IEC 60598-2-22: Suitable for emergency installations as central supply, non-maintained (Z0)

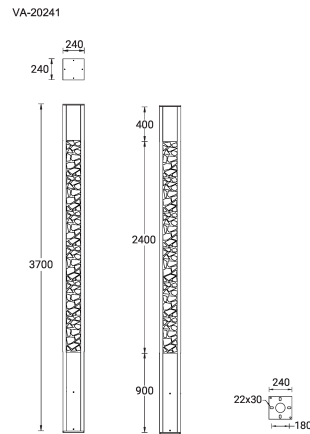

VANCOUVER 52 (VA-20241)**Accessory**



Circuit breaker box IP44
A21291



Root mount kit
A21391



DALI Control System
Control-DALI