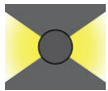

VERANDA 3 (VR-70293)**Product description**

Large

**Luminaire Structure**

- Single cable entry
- One IP68 connector supplied with 0.2 m of 3x1.0 sqmm outdoor cable
- High-efficiency polycarbonate lens
- Integral control gear

Optic

G

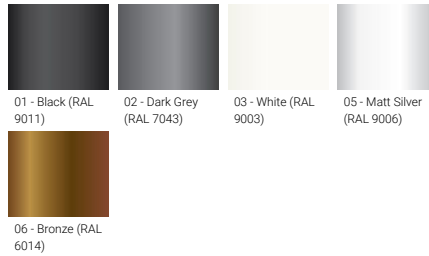
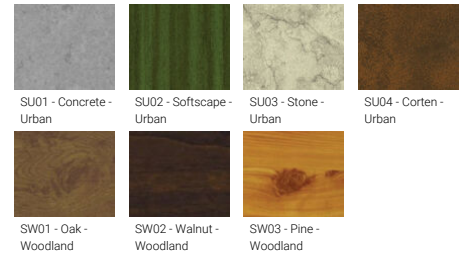
Product colour**Special finishes upon request**

VERANDA 3 (VR-70293)

Technical information

Material	Aluminium	Input voltage	220-240 V 50/60 Hz	Operating temperature	-20 °C to 40 °C
Light source	2 x 1 COB	Optic	G	Cable	One IP68 connector supplied with 0.2 m of 3x1.0 sqmm outdoor cable
Power	8 W	Optic value	90° / 90°	Through wiring	Single cable entry
Lumen	250 - 269 lm	CCT / CRI	3000K CRI80, 4000K CRI80	Lens / Reflector / Optic	High-efficiency polycarbonate lens
Efficacy	31 - 34 lm/W	Dimming type	On/Off, 1-10V, DALI	MacAdam Ellipse	3 SDCM
Driver option	Integral control gear	Product colours	Black, Dark Grey, White, Matt Silver, Bronze, Concrete - Urban, Softscape - Urban, Stone - Urban, Corten - Urban, Oak - Woodland, Walnut - Woodland, Pine - Woodland	Lifetime L90B10 (hours)	> 50,000
Driver	Constant current (CC)			Variants (On/Off, 1-10V, DALI)	Compatible with EN/ IEC 60598-2-22: Suitable for emergency installations as central supply, non-maintained (ZO)
		Weight	5.8 kg		

Veranda 3

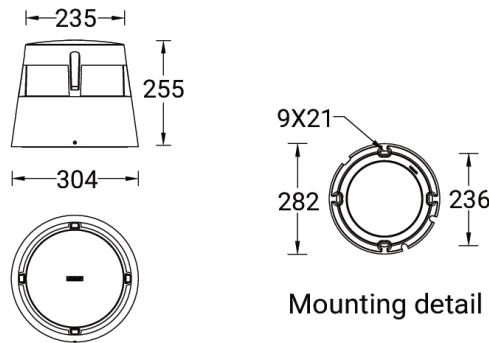

Accessories

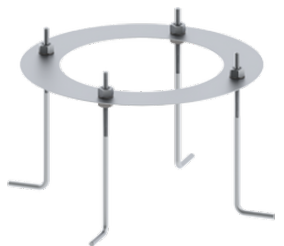

Anchor bolt
A70191